

<https://doi.org/10.23939/jtbp2020.01.064>

Vasyl Zhelykh, Khrystyna Kozak, Bogdan Piznak, Yurii Furdas, Andrii Stadnyk

EXPERIMENTAL RESEARCH OF PERFORMANCE CHARACTERISTICS FOR POLYPROPYLENE PRE-INSULATED PIPES

*Department of Heat and Gas Supply and Ventilation,
Lviv Polytechnic National University
cr__i@ukr.net*

Ó Zhelykh V., Kozak K., Piznak B., Furdas Y., Stadnyk A., 2020

This paper highlights the main causes of heat losses in heat networks and methods, that can significantly reduce heat losses, which means to increase the efficiency of heat supply systems.

The results of experimental research on determination of thermal and technical characteristics of pre-insulated pipes are presented in the paper. Experimentally, the data on the thermal conductivity of the closed-cell foam samples were obtained.

The study was conducted in two popular ways using advanced equipment. As a result, the obtained data was compared and the error of the experiment was determined, which did not exceed the admissible values.

In addition, the characteristics of popular thermal insulation materials for heat transfer network – mineral wool and polyurethane foam were compared. From the obtained comparison, it is clear that polyurethane foam is a modern material with high thermal performance, is safe for humans and retains its properties over a long period.

Key words: pre-insulated pipe, coefficient of thermal conductivity, closed polyurethane foam

Introduction

In modern conditions of rapid development of technologies and sharp growth of energy consumption, rational use of thermal energy is a necessary factor of cost-effective functioning of industrial enterprises and objects of heat power industry. While up to 70% of heat is lost when transported to the consumer, the topic of research is very relevant. Heat losses in the areas of transport of the heat transfer medium to the consumer include (Vashishishak et al., 2007); (Giurca, 2015):

- losses of thermal energy along the length of the heat line related to the method of laying and the type / quality of thermal insulation of pipelines;
- heat losses due to the uneven and inaccurate distribution of heat between its customers, as well as the lack of quality hydraulic adjustment of the heating system.
- leakage of coolant, which periodically occur during emergencies and emergencies, which often occur due to the high degree of wear of pipelines and thermomechanical equipment of thermal networks, destruction of the waterproofing shell and thermal insulation layer under the influence of corrosive environments and groundwater, no anti-activity, no warning settings (Law of Ukraine, 2017).

The economic feasibility of district heating in large cities is largely determined by the durability of the pipelines and the quality of their thermal insulation. Solution of problems of thermal networks is possible when using pre-insulated pipes (Matusevych et al., 2016).

The world and domestic experience of the last decades shows that the most effective solution to the above problems is the widespread implementation in the construction of thermal networks of pipelines

with polyurethane foam thermal insulation. In this construction, the polyurethane insulated steel pipes are protected by an outer pipe-shell made of polyethylene with a ductless gasket or a steel protective coating when laying above ground. Pipe insulation is carried out at the factory, and work on the isolation of butt joints is carried out at the installation site.

It follows from the foregoing that the use of modern high-quality thermal insulation of heat pipelines is an efficient and extremely important method that allows reducing heat loss by 30%. Thermal insulation is provided for linear sections of pipelines of thermal networks, fittings, flange connections, compensators and pipe supports for aboveground, underground channel and channelless gaskets (Dasdemir et al., 2017).

The most important indicator of the quality of the insulation is its thermal conductivity. However, due to the complexity and dynamism of thermal processes, standardized relatively accurate methods of measuring the thermal conductivity of building materials require considerable time to produce special samples of the material being tested, and to carry out expensive and bulky equipment to implement them. The quality of all thermal insulation materials for pipelines must be monitored not only during initial certification, but also during production, and when necessary, and when delivered to construction sites (DSTU B B.2.7-41-95, 1995).

Currently, there are many options for insulation of network pipelines: mineral and fiberglass, foamed rubber, polymer concrete and the like. One of the most popular insulation is polyurethane foam. The advantages of PPU-insulated pipelines include the low coefficient of thermal conductivity of PPPs (0.032–0.04 W/(m·K)), the manufacturability in the manufacture and installation of heat pipes, the durability of meeting the requirements of installation and operation (DSTU-N B V.2.5-35:2007, 2008).

This article describes the data obtained from experimental studies that have been conducted to determine the thermal performance of pipes currently available on the market.

Target of this article

This article presents the results of the study of thermal characteristics of pre-insulated foamed polyurethane pipes.

Techniques used

In Ukraine, the construction standard (DSTU B B.2.7-41-95, 1995), which regulates the method of determining thermal conductivity by a surface transducer, operates. The standard applies to building materials and products with a thermal conductivity of 0,02 to 1,0 W/(m·K) and establishes a method of non-destructive accelerated determination of thermal conductivity in the temperature range 278–313 K (5–40 °C). The method is to create a one-sided short-term thermal pulse on the surface of the product and to record the temperature change on that surface. The method is based on the analytical solution of the problem of non-stationary thermal conductivity in the system of two tangent semi- infinite bodies, whose contact zone is operated by a pulsed heat source (Platunov et al., 1986).

The BI-T021A device was used for testing by this method. This measuring complex (Fig. 1) consists of:

- the primary transducer 2 mounted on the product under test 1, designed to convert the electrical energy pulse into thermal and generate an electrical signal that characterizes the change in the surface temperature of the product material under the influence of thermal pulse;
- a secondary measuring device 4 for recording the electrical signal;
- pulse current source 3 with a timer heat pulse that provides heating of the plate of the primary transducer.

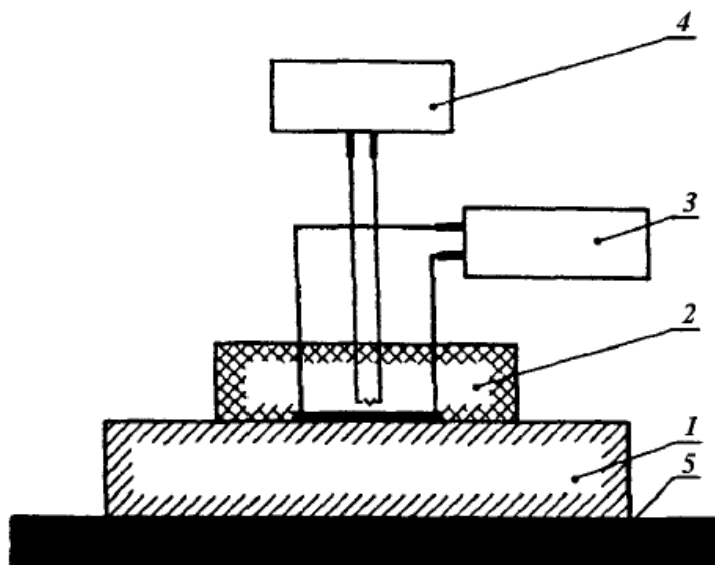

Fig. 1. Diagram of the measuring complex for determining the thermal conductivity of the materials of research products: 1 – study material; 2 – primary converter; 3 – pulse current source; 4 – the secondary measuring device; 5 – base

The tests are carried out at a stable thermal equilibrium between the product under study, the body of the primary transducer and the environment, for which the primary transducer is mounted on the surface of the product and kept until a secondary measuring device of constant performance appears on the display. They record a steady signal coming from the primary converter and include automatic recording of the values of that signal. A heat pulse is applied and a signal change proportional to the excess surface temperature of the test article is detected at regular intervals.

Registration is carried out until duplicate values appear. The values of thermal conductivity of the investigated product is determined when processing the array of experimental data.

The standard (DSTU B B.2.7-41-95, 1995) states that “the error in determining the thermal conductivity of this method is not more than 7 %”. However, the operation of such a device revealed a number of disadvantages inherent in the method. First of all, it is necessary to provide a high flat surface area of the product on which the primary transducer is installed. Small surface irregularities can lead to a gap between the heater and the surface of the product, causing distortion of the non-stationary thermal field compared to the theoretical solution and increasing the measurement error.

The second disadvantage is the need to install workspaces of different materials, depending on their density. The workspace is understood to mean some limited range of values of an experimental data set for which the calculation formulas used can be considered correct.

The need to pre-set the work area for each of the controlled materials is related to the application of simplifications in solving the problem of non-stationary thermal conductivity and, accordingly, to the simplified calculation formulas used. These disadvantages of the method lead to measurement uncertainty – a significant excess of the measurement error compared to the value specified in the standard.





Products that meet the requirements of the regulatory documents for these products are selected for testing. Products must have a flat surface to accommodate the primary transducer and provide thermal contact between them.

It is allowed to determine thermal conductivity on products of the correct and irregular shape. The number of products selected for testing shall be specified in the regulatory documents for these products, but not less than three.

Using the BI-T021A device, the following foam samples were tested:

Table 1

The results of experimental studies thermal conductivity of polyurethane prototypes

No.	Photo with samples	Name of sample	Coefficient of thermal conductivity, W/(m·K)
1		“The New Sample” (polyurethane foam parallelepiped made the day before experiments)	0.046
2		“Old sample” (polyurethane foam parallelepiped made several months before the experiments)	0.047
3		Sample in a plastic pipe	0.036
4		“Smooth Sample” (parallelepiped molded, with smooth surface and closed pores of polyurethane)	0.031
5		Standard Sample	0.05

To verify the accuracy of the data obtained, studies were conducted using an alternative method of determining the coefficient of thermal conductivity, namely, the Christiansen method.

Determination of the of thermal conductivity coefficient by the Christiansen method

The flat layer method (the Christiansen method) is a relative method for determining the coefficient of thermal conductivity λ_x , W/(m·K), that is, based on the use of a reference material for which the coefficient of thermal conductivity is known in advance λ_{et} , W/(m·K) (Kazarynovskiy & Tareev, 1980).

The experimental installation was a system of two tightly connected plates made of different material (one of which is a reference) (Fig. 2). The temperature T_2 at the boundary between them is the same (Stroy & Girman, 2007; Bryukhanov & Shevchenko, 2012)). The temperature varies along the layer. In the stationary case, the heat flow through the two plates is unchanged. This allows writing the equation:

$$\frac{l_{et}}{h_{et}}(T_1 - T_2) = \frac{l_x}{h_x}(T_2 - T_3) \quad (1)$$

where h_{et} and h_x – the thicknesses of the plates, m; T_1, T_2, T_3 – respectively, the temperature on the surface of the reference sample, the temperature between the two samples, the temperature on the surface of the test sample, °C.

The final formula for determining the unknown thermal conductivity of the test substance is:

$$l_x = l_{et} \frac{h_x}{h_{et}} \frac{(T_1 - T_2)}{(T_2 - T_3)} \quad (2)$$

Thus, to determine λ_x it is necessary to know the thickness of the reference and test materials h_{et} and h_x , as well as the magnitude of the temperature stresses on both sides of the contact layer $\Delta T_{et}=(T_1-T_2)$ and $\Delta T_x=(T_2-T_3)$.

Given that the formula is obtained under conditions where the coefficient of thermal conductivity does not depend on the temperature, the value λ_x thus determined is attributed to the average temperature of the material under study. The installation consists of two plates (Fig. 2). Plate 1 is considered a reference plate 2 is a sample of the material whose thermal conductivity is to be determined. These plates are tightly connected to each other.

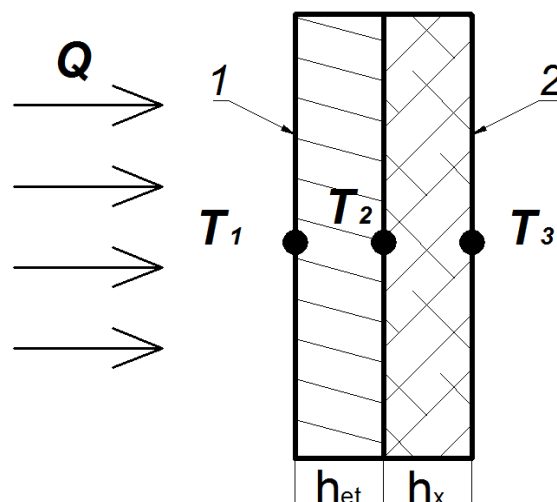







Fig. 2. Installation diagram for the Christiansen method
1 – standard plate; 2 – test sample; Q – heat flow

This method was used to re-investigate thermal conductivity coefficient of the test specimens to confirm the adequacy of the data obtained.

Table 2

**The results of experimental studies of the thermal conductivity coefficient
of polyurethane prototypes using the Christiansen method**

No.	Photo with samples	Name of sample	Coefficient of thermal conductivity, W/(m·K)
1		“The New Sample” (polyurethane foam parallelepiped made the day before experiments)	0.05
2		“Old sample” (polyurethane foam parallelepiped made several months before the experiments)	0.052
3		Sample in a plastic pipe	0.04
4		“Smooth Sample” (parallelepiped molded, with smooth surface and closed pores of polyurethane)	0.034
5		Standard Sample	0.05

As a result, of the comparison of the results obtained in both studies, it was concluded that the discrepancy does not exceed 10 %. Therefore, using the BI-T021A instrument, reliable values of the coefficient of thermal conductivity of the samples were obtained.

On the basis of the data obtained as a result of the experimental researches, a comparison of the thermal characteristics of the polyurethane heater with the traditional mineral wool heater was made (DSTU-N B V.2.5-3:2007, 2007; DSTU B B.2.5-31: 2007).

Table. 3

**Comparative analysis of technical and ecological efficiency
when using as thermal insulation pipelines thermal networks
of traditional structures of mineral wool and polyurethane foam**

Indicators	Mineral wool (first year of use)	Mineral wool (second year of use)	Polyurethane foam
Coefficient of thermal conductivity, W/(m·K)	0.05–0.07	0.1–0.15	0.031
Moisture, aggressive media	The thermal insulation properties have deteriorated significantly and cannot be restored		The insulation coating has a smooth surface and closed pores of foam, which contributes to the stability, properties do not change during the lifetime
Environmental friendliness	Allergen		Safe, permitted use in residential houses
Actual heat losses	Regulatory	In 2–3 times higher standard	Below regulatory loss of heat. The amount of heat supplied through the pipe wall of different diameters at different temperature differences is given in Section 2

In modern Ukraine, the use of pipes with pre-insulated polyurethane foam is considered the most effective solution for heat supply systems, since the coefficient of thermal conductivity is low enough, the temperature range in the range from $-70\text{ }^{\circ}\text{C}$ to $+150\text{ }^{\circ}\text{C}$, and the antihyrosopicity of the foam polyurethane allows to maintain stable parameters of construction 30 years. The monolithic construction of pipes thanks to high adhesion is characterized by high mechanical strength, which makes it possible to reduce heat losses up to 1.5–2 %.

Conclusions

1. According to the studies it was found that the coefficient of thermal conductivity of the samples with smooth foamed polyurethane is $0.031\text{ W}/(\text{m}\cdot\text{K})$, which is a good indicator and will provide low heat losses from the heat networks.

2. Comparison of the performance characteristics of traditional insulation for thermal networks – mineral wool, as well as modern polystyrene foam. It is concluded that polystyrene foam has the best performance and is safe for people.

References

- Vashishishak I. R., Vashishishak S. P., Mindyuk V. D., Chekhovsky S. A. (2007). Methods of estimation of thermal losses of underground thermal networks. *Energy, control and diagnostics of objects of oil and gas complex. Oil and Gas Energy*, 2 (3) (in Ukrainian).
- Giurca I. (2015). Calculation of heat loss through the pipes of the interior central heating system. *Journal of applied engineering sciences*, 5(18), pp. 29–36.
- Law of Ukraine “On District Heating” of 02.06.2005 (2017). No. 2633-IU. (in Ukrainian).
- Matushevych V., Zhelykh V., Savchenko O. Improving efficiency of heat exchange of horizontal ground-air heat exchanger for geothermal ventilation systems. *Fizyka budovli w teorii i praktyce*, 8(4), pp. 43–56.
- Dasdemir A., Ural T., Erturk M. (2017). Optimal economic thickness of pipe insulation considering different pipe materials for HVAC pipe applications. *Applied Thermal Engineering*, 121, pp. 242–254
- Thermal and hot water networks using pre-insulated pipelines. Instruction on design, installation, acceptance and operation. DSTU-N B V.2.5-35:2007. (2008). (in Ukrainian).
- Building materials and products. DSTU B B.2.7-41-95 (GOST 30290-94). (1995). Method of determination of thermal conductivity by a surface converter (in Ukrainian).
- Platunov E. S., Burava S. E., Kurepin V. V., Petrov G. S. (1986). Thermophysical measurements and devices. – L.: Mechanical Engineering. – 256 p. (in Russian).
- Kazarynovskiy D. M. Tareev B. M. (1980). Research of insulating materials and products. Textbook for technical schools, Energy, Leningrad, p. 216. (in Russian).
- Stroy A. F., Girman L. V. (2007). Calculation of closed air layers in enclosing structures. Bulletin Theory and practice of construction: a collection of articles. Publishers. National University Lviv Polytechnic, No. 600, pp. 297–301. (in Ukrainian).
- Bryukhanov O. N., Shevchenko S. N. (2012). Heat and mass transfer. Tutorial. M.: Infra-M., 464 p.: ill. (Higher Education: Undergraduate). (in Russian).
- Heat networks and hot water networks using pre-insulated pipelines guide to the design, installation, reception and operation. DSTU-N B V.2.5-3:2007. (2007). (in Ukrainian).
- The pipelines are pre-insulated with foamed polyurethane. DSTU B B.2.5-31: 2007. (2007). Kiev. (in Ukrainian).

В. М. Желих, Х. Р. Козак, Б. І. Пізнак, Ю. В. Фурдас, А. В. Стадник
Національний університет Львівська політехніка,
кафедра теплогазопостачання та вентиляції

ЕКСПЕРИМЕНТАЛЬНІ ДОСЛІДЖЕННЯ ЕКСПЛУАТАЦІЙНИХ ХАРАКТЕРИСТИК ПОПЕРЕДНЬО ІЗОЛЬОВАНИХ ПОЛІПРОПІЛЕНОВИХ ТРУБ

Ó Желих В. М., Козак Х. Р., Пізнак Б. І., Фурдас Ю. В., Стадник А. В., 2020

У сучасних умовах стрімкого розвитку технологій із різким зростанням енергопотребителів необхідним фактором економічно ефективного функціонування промислових підприємств і об'єктів теплоенергетики є раціональне використання теплової енергії. Тоді як до 70 % тепла втрачається при її транспортуванні до споживача, завдання пошуку енергоощадних рішень є надзвичайно актуальним. Застосування сучасної якісної теплової ізоляції трубопроводів теплової мережі є ефективним та надзвичайно важливим методом, який дозволяє скоротити втрати теплоти на 30 %. Тепловою ізоляцією передбачають для лінійних ділянок трубопроводів теплових мереж, арматури, фланцевих з'єднань, компенсаторів і опор труб для надземної, підземної каналної і безканалної прокладки. Найважливішим показником якості утеплювача є його теплопровідність. Проте, внаслідок складності та динамічності теплових процесів стандартизовані, відносно точні методи вимірювань теплопровідності будівельних матеріалів потребують значних затрат часу на виготовлення спеціальних зразків досліджуваного матеріалу, проведення випробувань, а для їх реалізації – дорогого і громіздкого обладнання. Якість усіх теплоізоляційних матеріалів трубопроводів необхідно контролювати не

тільки при початковій сертифікації, а й під час випуску на виробництві та за необхідності – і при постачанні на будівельні майданчики.

Є достатньо багато варіантів утеплення мережевих трубопроводів: мінеральне та скловолокно, спінений каучук, полімербетон тощо. Одним з популярних утеплювачів є пінополіуретан. До переваг теплопроводів з ППУ-ізоляцією зараховують низький коефіцієнт теплопровідності ППУ (0,032–0,04 Вт/(м·К)), технологічність виготовлення і монтажу теплопроводів, довговічність за дотримання вимог монтажу та експлуатації.

Наведено результати експериментальних досліджень щодо визначення тепло-технічних характеристик попередньо ізольованих труб. Згідно з даними, отриманими експериментальним шляхом, коефіцієнт теплопровідності гладкого зразка пінополіуретану із закритими порами становить 0,031 Вт/(м·К), що є високим показником та відповідає вимогам, встановленим до теплової ізоляції трубопроводів.

Порівняно теплотехнічні характеристики популярних сьогодні теплоізоляційних матеріалів, які використовують для теплових мереж – мінеральної вати та пінополіуретану. З порівняння зрозуміло, що пінополіуретан має кращі теплотехнічні характеристики, а також є безпечним для людини та може використовуватися у житлових приміщеннях.

Ключові слова: попередньо ізольована труба, коефіцієнт теплопровідності, закриті пори пінополіуретану.