

Andriy Kuzyshyn, Andriy Batig

Lviv Research Institute of Forensic Science, Lviv, Ukraine

INVESTIGATION OF INFLUENCE OF THE TRAIN MOTION SPEED ON THE PROCESS OF THE ROLLING STOCK DERAILMENT IN THE PRESENCE OF RAILWAY TRACK OBLIQUE

Received: May 22, 2017 / Revised: June 25, 2017 / Accepted: June 26, 2017

© Kuzyshyn A., Batig A., 2017

Abstract. The article is aimed to construct the plots of speed range change, at which the necessary and sufficient condition of wheel rolling onto the rail head is satisfied, on the basis of generally accepted methodologies of the wheelset off-loading calculation. First of all, for the specific example, it is necessary to define the value of the train motion speed, at which it takes place the largest wheel off-loading on the curved section of the track with the existing oblique, to determine the minimal height of the oblique, at which the change of the train speed will not lead to the satisfaction of the necessary condition of wheel rolling onto the rail head. One should also construct a generalized scheme of checking the conditions of the rolling stock derailment if there is a railway track oblique of the certain value.

In order to determine the influence of the train motion speed on the satisfaction of conditions of the car wheel rolling onto the rail head, it is necessary to solve the system of differential equations that describes the motion of the over-spring part of the rolling stock on the oblique track section under the influence of the forces applied to it.

As a result of research carried out, there was obtained the value of train motion speed, at which the largest off-loading of the car wheel on the curved track section with oblique takes place. There was defined the minimal oblique value, at which the change of the train motion speed will not lead to the satisfaction of the necessary condition of the wheel rolling onto the rail head. There were constructed the plots of changing the speed range, at which the necessary and sufficient condition of car wheel rolling onto the rail head is satisfied. In the article, there was constructed the generalized scheme of checking the conditions of the rolling stock derailment if there is a railway track oblique.

There were determined the speed ranges, at which the rolling stock derailment may occur if there is a railway track oblique of the certain value. There was defined the value of the train motion speed, at which the largest off-loading of the car wheel on the track curved section with the skew takes place.

The obtained dependencies may be used for defining the safe range of the train motion speeds on the track sections with oblique of the certain value. They may be also used while carrying out the forensic railway-transport examinations.

Keywords: train motion speed, necessary and sufficient condition of rolling onto, oblique, freight car, curved track section.

Introduction

If the railway crew is on the track in a static position, so only the weight of this crew acts upon the track. Herewith, the reactions of rails act upon the wheels of the crew. The sum of these reactions is equal to the weight of the crew. During the motion of the crew, the interaction between the track and the rolling stock is much more complicated [1; 2; 3].

The sources of excitation of various oscillatory processes are the existing tolerances, which occur while manufacturing and maintaining the rolling stock and the track [11].

As it is indicated in [5; 12; 13; 14], the oblique of the rails lines is the source of forced oscillations of the over-spring body of the transport crew. Eventually, these oscillations cause the occurrence of dynamic

loads, which act upon the elements of the structure of the rolling stock and of the railway track. If the dynamic load is less than static one, so the off-loading of the investigated element occurs. And if the dynamic load is larger than static one, so there is the overloading of this element [4; 6].

Problem statement

The analytical expression of the necessary condition of the car wheel ridge rolling onto the rail head (Fig. 1) has the following form:

$$P_1 < P_1^*, \quad (1)$$

where P_1 is the actual load influencing the wheel; P_1^* is the load acting upon the wheel, at which the process of wheel rolling onto the rail starts.

The load acting upon the wheel, at which the process of wheel rolling onto the rail starts, may be determined by the following expression [7; 8]:

$$P_1^* = \frac{Cb_2 + Y_p r - Gl}{b_1 + b_2}, \quad (2)$$

where $C = (P_1 + P_2)$ is the static load acting upon the wheelset; b_2 is the distance between the point of application of the force P_2 and the middle circle of rolling of the second wheel; r is the radius of the wheel; G is the weight of the wheelset; $2l$ is the distance between the circles of rolling of the wheels; b_1 is the distance between the point of application of the force P_1 and the middle circle of rolling of the second wheel; Y_p is the frame force [1; 9; 10].

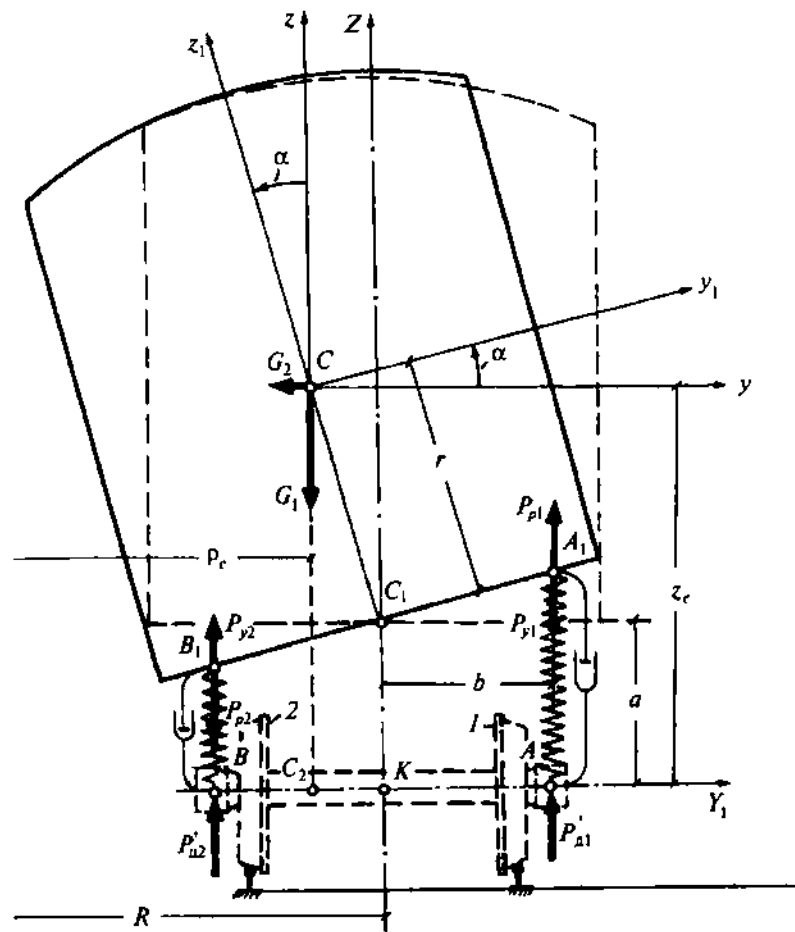

Fig. 1. Calculation diagram of force interaction between the track and the rolling stock when passing the track irregularities

Let us determine the forces P_1 and P_2 using the following formulas [8]:

$$P_1 = P_{ct1} - \Delta_{d1}, \quad (3)$$

$$P_2 = P_{ct2} + \Delta_{d1}, \quad (4)$$

where Δ_{d1} is the off-loading of the wheel 1 if there is the railway track oblique.

The value of the wheel off-loading may be determined by the following formula [8]:

$$\Delta_{d1} = \frac{1}{2} G \cos g \left(\frac{r}{b} a + \frac{r}{g} a^2 - \frac{r}{g} \cdot \frac{r+a}{b} a \right), \quad (5)$$

where a is the angle of the body inclination when the car runs along the railway track with the oblique.

Using the formula presented in [7], the angle of the body inclination when the car runs along the railway track with the oblique may be determined as follows:

$$a = \frac{h_1}{k^2} + \left(a_0 - \frac{h_1}{k^2} \right) \cos kt + \left(\frac{a_0}{k} - \frac{h}{k^2 - p^2} \cdot \frac{p}{k} \right) \sin kt + \frac{h}{k^2 - p^2} \sin pt. \quad (6)$$

The frame force may be defined by the following formula [9; 10]:

$$Y_p = M \left[\left(\frac{u^2}{R} - \frac{h_0}{S^*} g \right) + r_c \left(a - a^2 \cdot a \right) \right]. \quad (7)$$

Let us present the case of satisfaction of the necessary condition of the wheel rolling onto the rail head in Fig. 2.

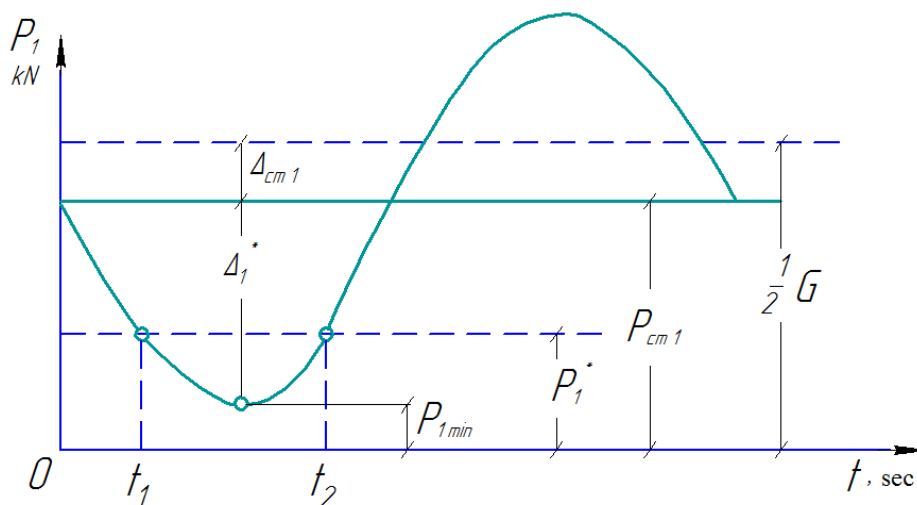

Fig. 2. The plot for checking the necessary condition of the wheel rolling onto the rail head

The satisfaction of the necessary condition of the wheel rolling onto the rail head does not indicate the fact of the rolling stock derailment. In this case, the wheelset may start moving in the opposite direction without rolling onto the active surface of the rail. Therefore, it is necessary to check the satisfaction of the sufficient condition for the wheel ridge rolling onto the head of the rail (Fig. 3). The detailed procedure of checking the sufficient condition of the wheel rolling onto the rail head is presented in [8].

The calculation was made for the following initial data: $r = 0.475$ m, $G = 207.5$ kN, $L = 8$ m, $c = 196.2 \cdot 10^4$ N/m, $R = 275$ m, $h = 90$ mm, $J_x = 11.9$ t(force) \cdot m \cdot s², $G_k = 14.126$ kN, $S = 1.6$ m.

The calculation was made for the covered four-axle car with the unworn running parts, which moves along the curved track section with the existing oblique.

Using the above presented methodology, the values of the wheelset wheel off-loading for a range of velocities of $v = 20 - 45$ km/h with the step of 1 km/h were calculated. The following values of the height of the rails lines oblique were taken into account: 20, 30, 37, 45 km/h.

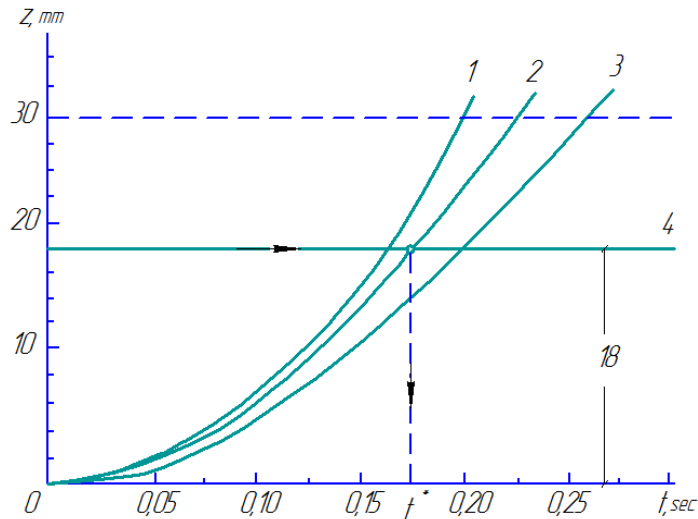

Fig. 3. The plot for checking the sufficient condition of the wheel rolling onto the rail head

Table 1

Off-loading the loaded car wheel at the height of irregularity 0.01 m

t	Value of the force at different speeds of the train motion							
	20 km/h		30 km/h		37 km/h		45 km/h	
	P_1^* , kN	P_1 , kN	P_1^* , kN	P_1 , kN	P_1^* , kN	P_1 , kN	P_1^* , kN	P_1 , kN
0	20,63	94,79	21,48	100,28	22,28	105,42	23,4	112,62
0,1	20,63	100,64	21,48	108,32	22,28	114,63	23,4	122,72
0,2	20,63	102,21	21,48	107,55	22,28	110,67	23,4	113,58
0,3	20,63	97,68	21,48	95,8	22,28	92,37	23,4	87,53
0,4	20,63	88,1	21,48	77,95	22,28	70,21	23,4	64,82
0,5	20,63	77,1	21,48	63,71	22,28	59,94	23,4	66,54
0,6	20,63	69,43	21,48	62,72	22,28	72,25	23,4	95,98
0,7	20,63	69,1	21,48	79,36	22,28	104,86	23,4	133,91
0,8	20,63	77,67	21,48	109,52	22,28	141,56	23,4	152,31

Table 2

Off-loading the loaded car wheel at the height of irregularity 0.02 m

t	Value of the force at different speeds of the train motion							
	20 km/h		30 km/h		37 km/h		45 km/h	
	P_1^* , kN	P_1 , kN	P_1^* , kN	P_1 , kN	P_1^* , kN	P_1 , kN	P_1^* , kN	P_1 , kN
0	20,63	94,79	21,48	100,28	22,28	105,42	23,4	112,62
0,1	20,63	106,75	21,48	117,09	22,28	125	23,4	134,61
0,2	20,63	110,53	21,48	117,4	22,28	120,09	23,4	120,94
0,3	20,63	102,23	21,48	96,18	22,28	87,22	23,4	74,64
0,4	20,63	83,71	21,48	62,43	22,28	46,05	23,4	33,97
0,5	20,63	62,03	21,48	34,74	22,28	26,59	23,4	38,86
0,6	20,63	46,49	21,48	31,76	22,28	49,53	23,4	95,61
0,7	20,63	45	21,48	62,57	22,28	111,42	23,4	167,11
0,8	20,63	60,97	21,48	120,43	22,28	181,56	23,4	198,35

Graphic dependence of P_1 on t_1 is presented in Fig. 4. For the other values of h , these dependences will be analogous to the presented one.

Table 3

Off-loading the loaded car wheel at the height of irregularity 0.0213 m

t	Value of the force at different speeds of the train motion							
	20 km/h		30 km/h		37 km/h		45 km/h	
	P_1^* , kN	P_1 , kN	P_1^* , kN	P_1 , kN	P_1^* , kN	P_1 , kN	P_1^* , kN	P_1 , kN
0	20,63	94,79	21,48	100,28	22,28	105,42	23,4	112,62
0,1	20,63	107,53	21,48	118,22	22,28	126,34	23,4	136,15
0,2	20,63	111,6	21,48	118,66	22,28	121,3	23,4	121,89
0,3	20,63	102,81	21,48	96,22	22,28	86,55	23,4	72,96
0,4	20,63	83,14	21,48	60,42	22,28	42,93	23,4	29,98
0,5	20,63	60,08	21,48	31	22,28	22,28	23,4	35,26
0,6	20,63	43,53	21,48	27,74	22,28	46,55	23,4	95,51
0,7	20,63	41,87	21,48	60,34	22,28	112,2	23,4	171,38
0,8	20,63	58,78	21,48	121,77	22,28	186,7	23,4	204,3

Table 4

Off-loading the loaded car wheel at the height of irregularity 0.025 m

t	Value of the force at different speeds of the train motion							
	20 km/h		30 km/h		37 km/h		45 km/h	
	P_1^* , kN	P_1 , kN	P_1^* , kN	P_1 , kN	P_1^* , kN	P_1 , kN	P_1^* , kN	P_1 , kN
0	20,63	94,79	21,48	100,28	22,28	105,42	23,4	112,62
0,1	20,63	109,8	21,48	121,47	22,28	130,19	23,4	140,55
0,2	20,63	114,68	21,48	122,3	22,28	124,77	23,4	124,59
0,3	20,63	104,47	21,48	96,32	22,28	84,6	23,4	68,16
0,4	20,63	81,47	21,48	54,64	22,28	33,97	23,4	18,54
0,5	20,63	54,47	21,48	20,26	22,28	9,88	23,4	24,91
0,6	20,63	35,02	21,48	16,18	22,28	37,94	23,4	95,19
0,7	20,63	32,89	21,48	53,87	22,28	114,39	23,4	183,6
0,8	20,63	52,45	21,48	125,53	22,28	201,44	23,4	221,37

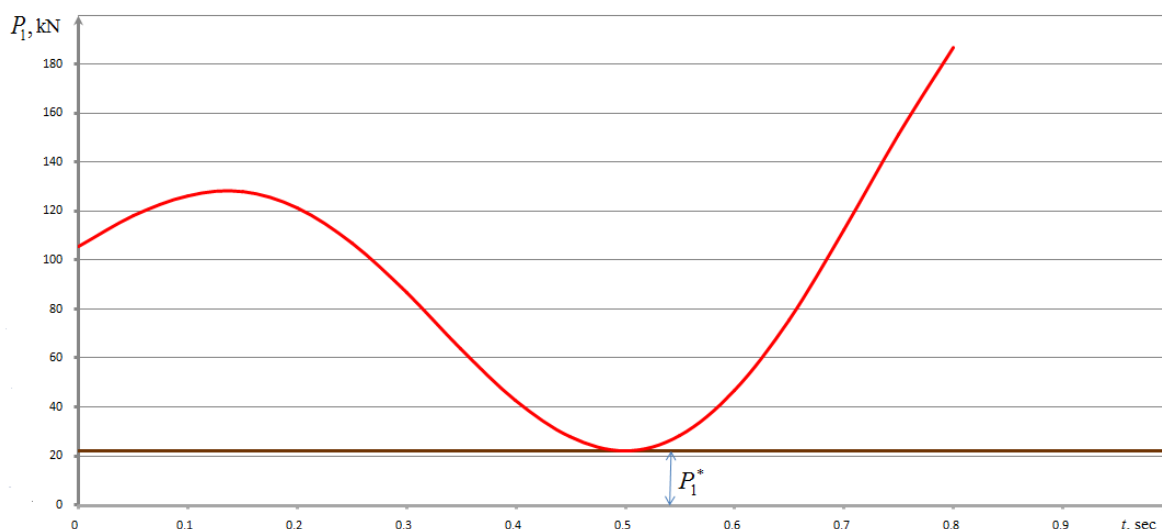

Fig. 4. The plot for checking the necessary condition of the wheelset rolling onto the rail head at $u = 37 \text{ km/h}$, $h = 0.0213 \text{ m}$

Subsequently, the calculations of the speed range change, at which the necessary condition of the wheel rolling onto the rail head is satisfied, were carried out and the corresponding plots were constructed (Fig. 5).

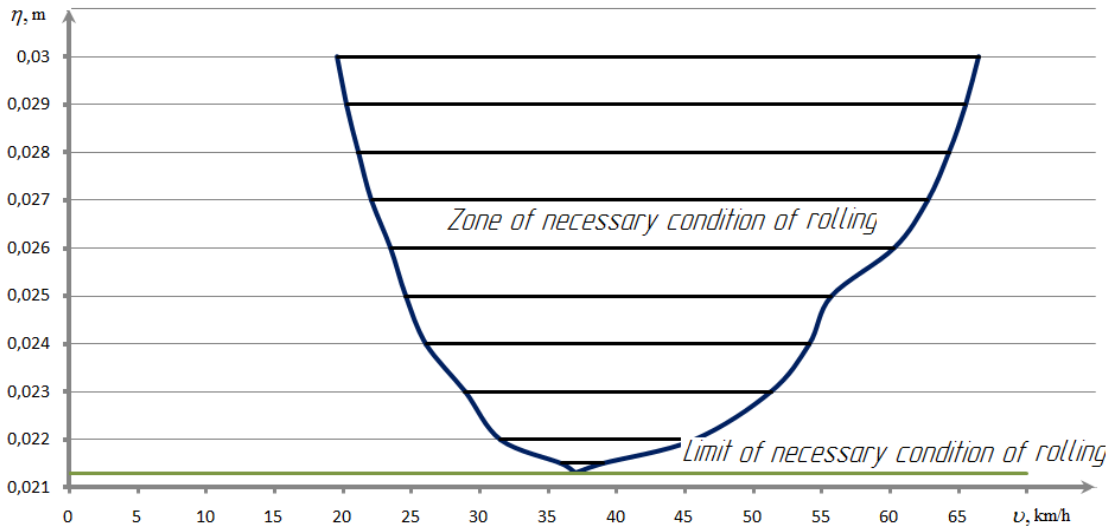

Fig. 5. The plot for checking the necessary condition of the wheel rolling onto the rail head at different speeds of the train motion

Also, the satisfaction of the sufficient condition of the car wheelset wheel rolling onto the rail head was analysed (Fig. 6).

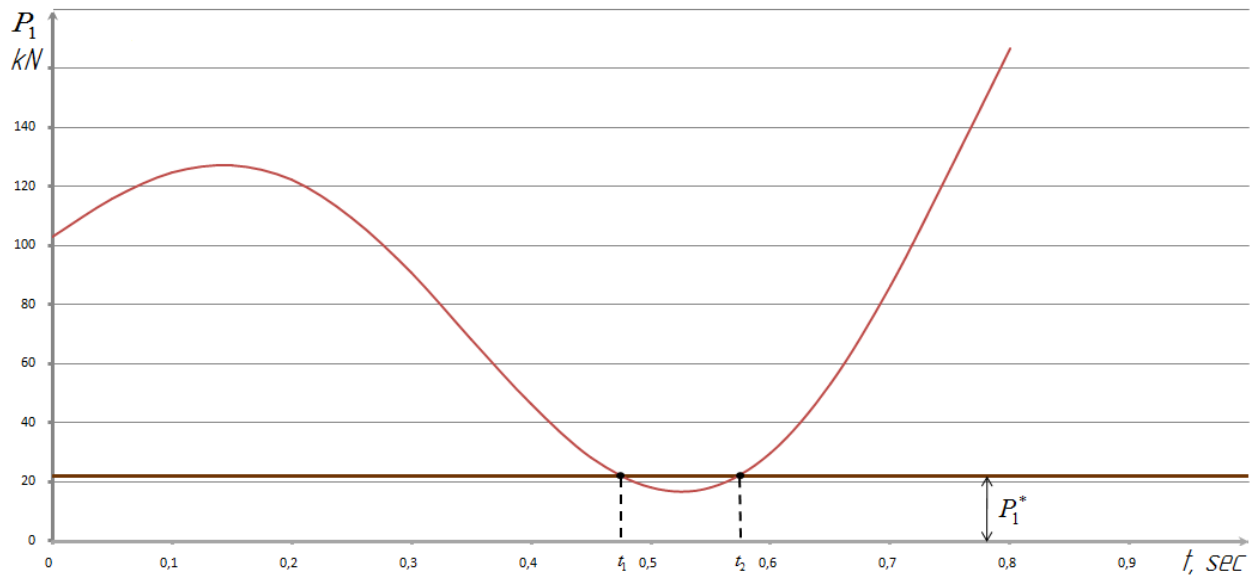

Fig. 6. The plot of changing the load on the wheel, which moves along the outer rail at the height of asynchronous track irregularity $h = 0.0232$ m

Using the technique of calculation of the sufficient condition of the wheel rolling onto the rail head, we obtained the dependence of the train motion speed on the height of the oblique, at which the time interval for the wheelset rolling onto the rail head is maximal (Fig. 7).

Carried out the calculations for the different values of speed, the minimal value of the oblique height $h \geq 0,0232$ m, at which the change of the train motion speed may cause the rolling stock derailment, was determined. The time needed for the wheelset wheel ridge to rise to the height of $z = 18.24$ mm equals $\Delta t = 0.099$ s. Since the time t^* needed for the wheel rolling onto the rail head equals 0.0984 s, so the sufficient condition of the wheel rolling onto the rail head is satisfied ($0,099$ s $>$ $0,098$ s).

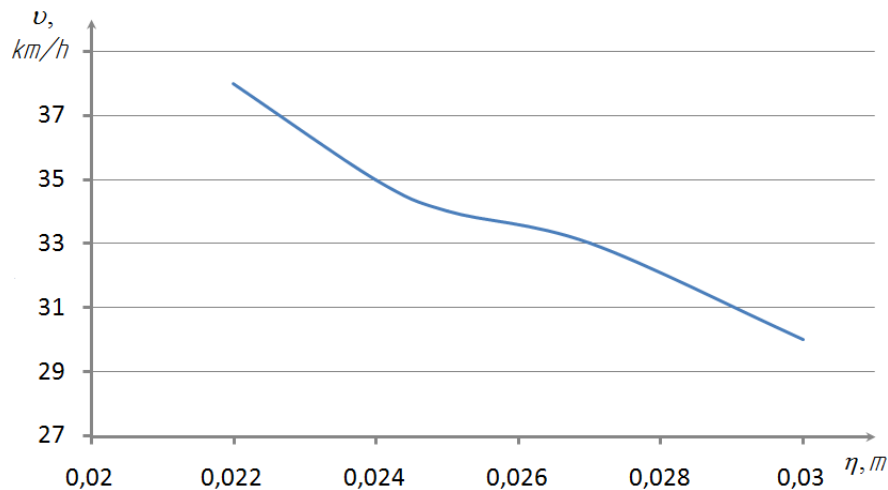

Fig. 7. The dependence $h = f(u)$ at $\Delta t \rightarrow \max$

It was also ascertained that at the oblique height of $h < 0,0232$ m, the change of the train motion speed will not lead to the satisfaction of the sufficient condition of the wheel rolling onto the rail head.

Subsequently, the calculations of the speed range change, at which the sufficient condition of the wheel rolling onto the rail head is satisfied, were carried out and the corresponding plots were constructed (Fig. 8).

The oblique height was being changed in the range of 0.024...0.029 m. Herewith, the length of the oblique wave was equal 8 m.

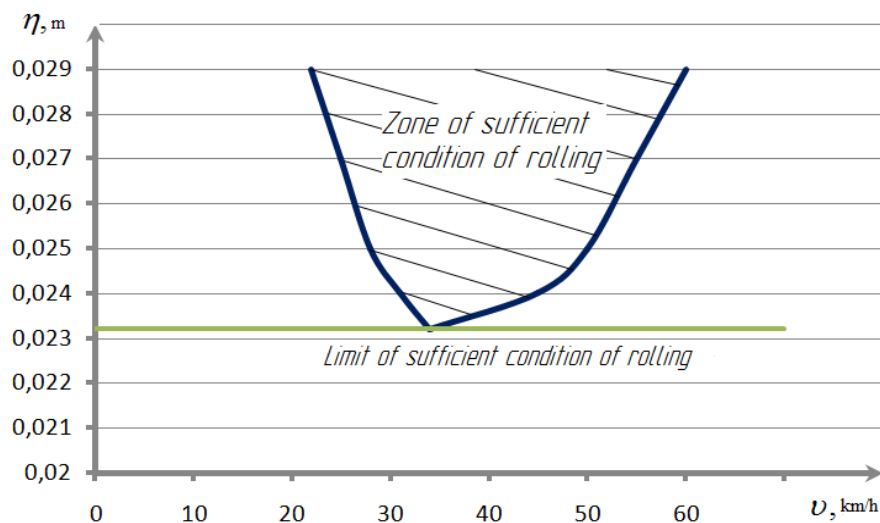

Fig. 8. The plot for checking the sufficient condition of the wheel rolling onto the rail head at different speeds of the train motion and the corresponding value of asynchronous track irregularity

On the basis of the previously obtained results, there was constructed the generalized plot of the dependence $h = f(u)$, on which the zones of motion safety, stasis (equilibrium) and derailment of the rolling stock were plotted (Fig. 9).

When overlaying the plots of the necessary and the sufficient conditions of the wheelset wheel rolling onto the rail head, three zones were obtained:

- the zone of the motion safety is the zone, in which the necessary condition is not satisfied;
- the stasis (equilibrium) zone is the zone, in which only the necessary condition is satisfied;
- the zone of the rolling stock derailment is the zone, in which the necessary and the sufficient conditions are satisfied.

It should be noted that similar investigations may be carried out in the presence of smooth synchronous irregularities on the railway track.

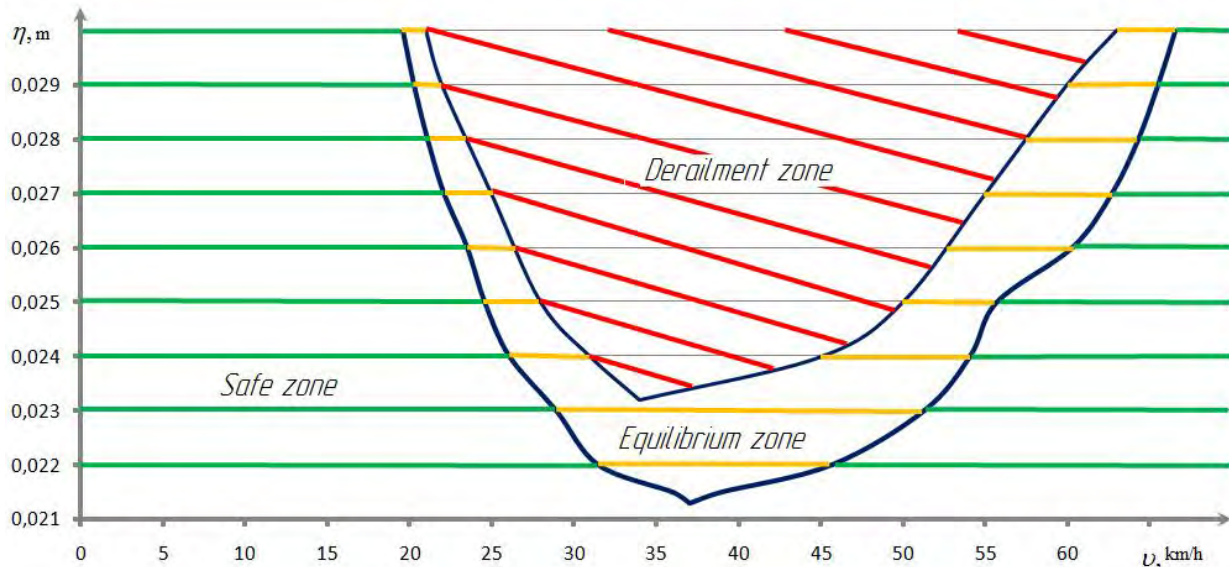

Fig. 9. The generalized plot for checking the conditions of the rolling stock derailment

Conclusions

1. There are defined the speed ranges, at which the necessary and the sufficient conditions of the wheel rolling onto the rail head are satisfied.
2. It was also ascertained that at the speed of 37 km/h, the largest off-loading of the car wheel on the curved track section with the existing oblique takes place.
3. It was ascertained that at the oblique height of $h \leq 0,0213$ m, the change of the train motion speed will not lead to the satisfaction of the necessary condition of the wheel rolling onto the rail head.
4. It was ascertained that at the oblique height of $h < 0,0232$ m, the change of the train motion speed will not lead to the satisfaction of the sufficient condition of the wheel rolling onto the rail head.
5. The generalized plot for checking the conditions of the rolling stock derailment is constructed.

References

- [1] Даніленко Е. І. Залізнична колія / Е. І. Даніленко // Улаштування, проектування і розрахунки, взаємодія з рухомим складом : підручник для вищих навчальних закладів (у 2-х т.). – К. : Інпрес, 2010. – Т. 2. – 456 с.
- [2] Даніленко Е. І. Новітні дослідження бічної пружності рейкових ниток при спільній дії вертикальних і горизонтальних сил / Е. І. Даніленко // Наука та прогрес транспорту. – 2015. – № 6 (60). – С. 65–77.
- [3] Коган А. Я. Динамика пути и его взаимодействие с подвижным составом / А. Я. Коган. – М. : Транспорт, 1997. – 326 с.
- [4] Коротенко М. Л. Сход с рельсов одиночной колесной пары. Силы, вызывающие сход, продолжительность схода / Коротенко М. Л, Рейдемейстер А. Г. // Проблемы механики железнодорожного транспорта: Динамика, надежность и безопасность подвижного состава: Тезисы докладов X Международ. конф. – Днепропетровск: Арт-Пресс, 2000. – С. 82–83.
- [5] Результаты эксплуатационных испытаний геометрически-силового метода оценки состояния пути / В. С. Коссов, А. Л. Бидуля, О. Г. Краснов, М. Г. Акашев // Наука та прогрес транспорту. – 2013. – № 5 (47). – С. 97–104.
- [6] Ромен Ю. С. Динамика железнодорожного экипажа в рельсовой колес. Методы расчета и испытаний / Ю. С. Ромен. – М. : ВМГ-Принт, 2014. – 210 с.
- [7] Сокол Э. Н. Железнодорожно-транспортное происшествие и его механизм (Судебная экспертиза. Элементы теории и практики) : монография. – Львів : ПАІС, 2011. – 376 с.

- [8] Сокол Э. Н. “Классический” сход с рельсов подвижного состава : метод. пособ. / Э. Н. Сокол, А. А. Переймыбида, Д. А. Радкевич // Под ред. Э. Н. Сокола. – К. : Феникс, 2006. – 168 с.
- [9] Сокол Э. Н. Крушения железнодорожных поездов (Судебная экспертиза. Элементы теории и практики) : монография. – К. : Феникс, 2007. – 355 с.
- [10] Сокол Э. Н. Сходы с рельсов и столкновения подвижного состава (Судебная экспертиза. Элементы теории и практики). – Киев : Транспорт України, 2004. – 368 с.
- [11] Спиридонов Б. К. Основы теории колебаний вагона на рессорном подвешивании / Б. К. Спиридонов. – Гомель : БелИИЖТ, 1972. – 258 с.
- [12] Чернышов М. А. Практические методы расчета пути / М. А. Чернышов. – М. : Транспорт, 1967. – 236 с.
- [13] A comprehensive model of the railway wheelset-track interaction in curves / José Martínez-Casas, Egidio Di Gialleonardo, Stefano Bruni, Luis Baeza // Journal of Sound and Vibration. – 2014. – Vol. 333. – Iss. 18. – P. 4152–4169.
- [14] Quantifying Rail-Highway Grade Crossing Roughness: Accelerations and Dynamic Modeling / T. Wang, R. R. Souleyrette, D. Lau [et al.] // Transportation Research Board : 94th Annual Meeting : № TRB15-4825. – Washington DC, USA. – 2015. – P. 2–11.

