

Mykola Karpenko, Marijonas Bogdevicius, Olegas Prentkovskis  
Vilnius Gediminas Technical University, Vilnius, Lithuania

## EXPERIMENTAL IMPROVEMENT OF THE TECHNOLOGY OF CUTTING OF HIGH-PRESSURE HOSES WITH METAL BRAID ON HAND CUTTING MACHINE

Received: October 24, 2016 / Revised: December 2, 2016 / Accepted: December 26, 2016

© Karpenko M., Bogdevicius M., Prentkovskis O., 2016

**Abstract.** In the article the review of the problem of improvement of technology of high pressure hoses cutting on the hand cutting machines is analyzed. Different methods of cutting of high pressure hoses into the billets are overviewed and the quality of edge cuts of hoses is analyzed. The comparison of treatment on automatic cutting machines and on hand cutting machines is carried out. Different experimental techniques of improvement of the quality of edges cutting of high pressure hoses are presented. On the basis of experimental method, a new cutting technology which consists in maximally close fixation of high pressure hoses to the cutting disc is proposed. In the basic design of the hand cutting machine, the only supports are provided, so that the cutting of the edge section of high pressure hoses causes the metal braid loosening. The proposed technology excludes the scrolling and bending of high pressure hoses during cutting, so that the loosening of metal braid is also excluded. In the paper it is shown that the scheme of distribution of cutting forces during the cutting of high pressure hoses is presented and the mathematical model of determination of normal and tangential cutting forces is formed. With a help of tensiometric table the values of components of cutting forces during free and fixed cutting of high pressure hoses were defined and their comparison was performed. As a result of the use of this technology the edges of the cut off high pressure hoses meet the necessary requirements without using of complicated technological processes.

**Keywords:** high pressure hose, metal braid, cutting force, hand cutting machine, tensiometric table, technological process, loosening.

### Introduction

Eventually, the machines based on hydraulic drive need to be repaired or the replacement of components of hoses of high pressure (HPH) to be done. HPH are used as flexible pipe in hydraulic systems of machines and mechanisms for transporting of mineral and hydraulic oils, fuel oil and water-oil emulsions and are widely used in road construction, mining, agriculture, forestry, oil and gas industries. HPH are influenced by significant loads and by significant pressure drops, ensuring stable operation of the equipment, so there is a need in the preparation of materials and components of HPH in accordance with the requirements. A technologically properly manufactured HPH ensures maximum performance of passing of the working fluid, and minimizes hydraulic losses. One of the massive operations during the manufacturing of HPH is cutting to the appropriate length. In most cases at small and medium enterprises the hand cutting machines are used. However, when using these machines there is a technological problem: the cut edge faces of the HPH does not meet the requirements for further usage [1], as loosening of metal braid does not allow to carry out the production operations, and in some cases there is an opportunity of metal parts getting into the hydraulic system.

### Statement of purpose and problems of research

The purpose of this work consists in improvement of the technology of cutting of high-pressure hoses with metal braid on hand cutting machines, and in experimental determination of changes of cutting forces under different parameters and cutting technologies with a help of tensiometric table.

### Main material

High-pressure hoses are used in hydraulic systems of various machines and mechanisms (construction and road machinery, forestry machinery, lifting and transporting equipment, tractor and agricultural machinery, industrial equipment, etc.) for transporting of hydraulic and engine oils, liquid fuel compatible oils and emulsions. As a rule, HPH are not reinforced, but they are strengthened by one or more layers of spiral/cross steel (coated by a brass) sheath in order to achieve the required reserve tensile strength. In most cases, the hose consists of three main elements: the inner rubber layer, or camera, reinforcing layer, or the strength frame, and the outer rubber layer, or the protective coating. The camera ensures hose tightness and its resistance to chemical and physical action of the working environment. Strength frame intended for the perception of mechanical strains caused by the internal or external pressure. The outer rubber layer protects the hose from the influence of external factors (abrasion and other mechanical stresses, weather conditions etc.) (Fig. 1) [2; 3; 4].

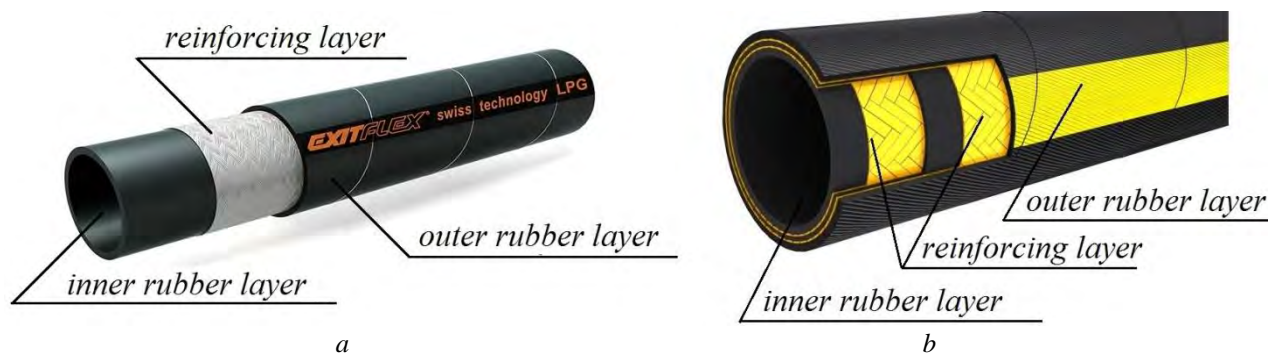

**Fig. 1.** Structure of HPH: *a* – with one metal braid 1SN; *b* – with two hoses with metal braid 2SN

At large enterprises which deal with the manufacturing of HPH (IMM Hydraulics, Hypress, Madejski) the modern servo cutting machines with variable serving of cutting discs are widely used (Fig. 2, *a*) [5; 6] that provides clean cut edge of the hose and the absence of loosening of metal braid (Fig. 3, *a*).

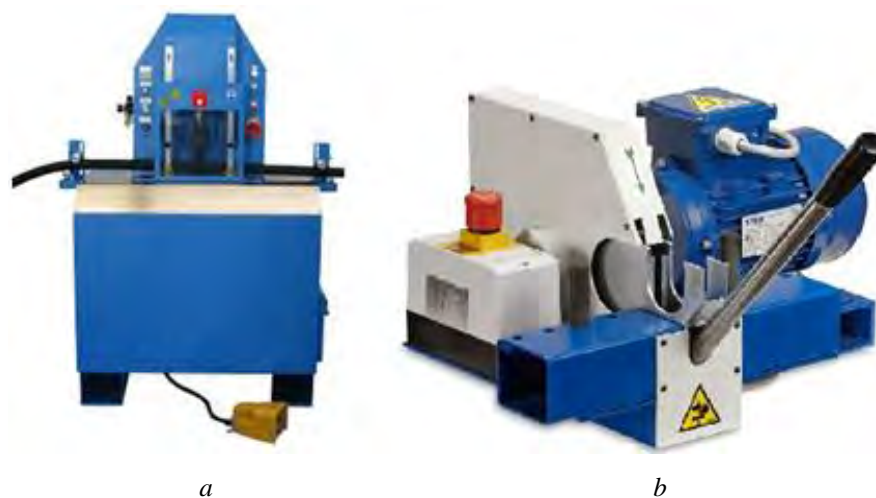

**Fig. 2.** Machines of hoses cutting:  
*a* – automatic cutting machine; *b* – hand cutting machine

When using the hand cutting machines (Fig. 2, *b*) [5; 6] the cut hose edges do not meet the requirements for further usage, as the loosening metal braid takes place (Fig. 3, *b*). As a result, the subsequent HPH manufacturing operations (crimping and fitting) can't be carried out without prior stripping of the edge, and in some cases there is an opportunity of metal parts getting into the hydraulic system when using such hoses.

To eliminate the loosening of metal braid while cutting at large enterprises the automated cutting machines with variable serving of cutting element and with the gradual fixation of HPH are used. In the hand cutting machines this technology is not available, that's why it's an important problem to improve the cutting technology in order to prevent the loosening of metal framework of hoses.

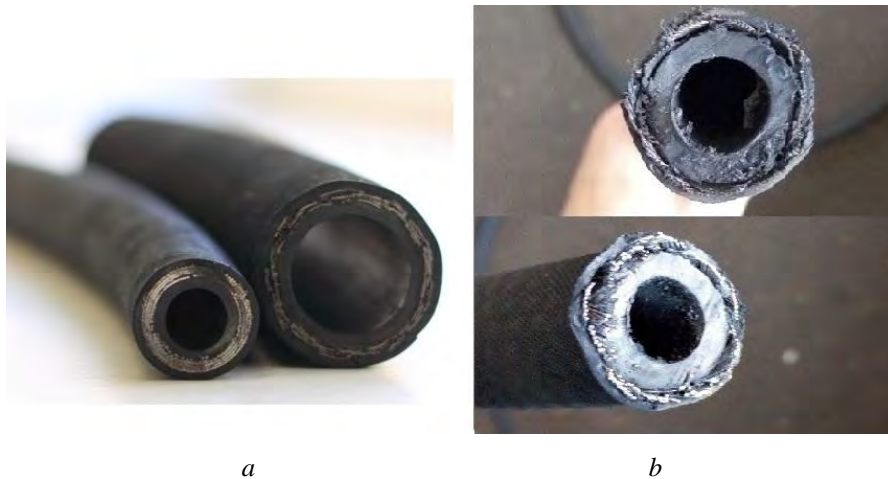

**Fig. 3.** Edge face cuts of a hose: *a* – on automatic machine; *b* – on hand cutting machine

The research was carried on the basis of the enterprise “Hydrohouse” (Kyiv, Ukraine). During the research, several technological tests of the effectiveness of elimination of metal braid loosening when cutting of the HPH on the hand cutting machine. Hoses with one metal braid 1SN and two metals braids 2SN were cut. One of the cutting methods consists in surface winding of heat-resistant fibrous film on the cutting place (Fig. 4, *a*). During the cutting, there are additional external loads  $P_d$ , which partially restrain the loosening of metal framework, but do not completely eliminate it. The usage of this method is inefficient and costly in continuous operation modes.

Another method consists in the supplying of compressed air along the whole length of HPH in order to create additional internal forces  $P_d$  (Fig. 4, *b*), as a result of which the alignment of internal and external forces, acting on the hose during the cutting, takes place. This method is not effective, because the time spent on permanent change of hoses of different diameters and constant connection / disconnect of supply of compressed air to the ends of the hose takes considerable time of the manufacturing process.



**Fig. 4.** Technological methods of improving of hoses cutting: *a* – surface winding by heat-resistant fibrous film; *b* – supply of compressed air

One of the most optimal methods of hoses cutting is cutting with hose rigid fastening (clamping) as close to the cutting element (cutting disc) as possible.

In the basic configuration of hand cutting machines (the scheme is shown in Fig. 5) there are only the abutments (bumpers) (A) that causes the scrolling and deflection of the hose when the cutting disc (C) moves to the stopper (B).

In the work the normal and tangential cutting forces were determined during the cutting of hoses with one (1SN) and two (2SN) metal braids. The research was performed while cutting by the “cut into” method. Power parameters were investigated on the experimental stand. The stand was established on the basis of hand cutting machine TAGLTF2D/E, which parameters are presented in Table 1.

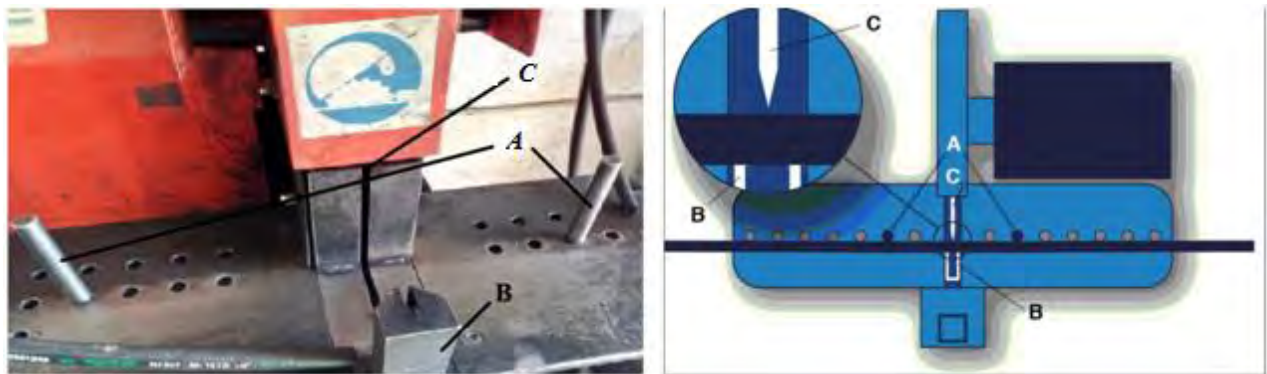

Fig. 5. Basic configuration scheme of hand cutting machine

Table 1

Parameters of hand cutting stand TAGLTF2D/E

| Article               | TAGLTF2D/E      |
|-----------------------|-----------------|
| 2 braids              | 2"              |
| 4 windings            | 2"              |
| 6 windings            | 1 1/2"          |
| Max Ø                 | 75 mm (2.953")  |
| Rpm                   | 2900            |
| disc Ø, mm            | 250 mm (9.843") |
| Measurement error     | ± 2 %           |
| Standard voltage      | 400V 50 Hz 3Ph  |
| Engine power, kW      | 3               |
| Weight, kg            | 42              |
| Dimensions (L×W×H) mm | 665×700×420     |
| Suction branch        | yes             |
| Protective system     | yes             |

The suggested method of hoses cutting consists in hose rigid fastening (clamping) as close to the cutting disc as possible (Fig. 6) and in increasing of the feed rate of the cutting disc. As a result, the movement of the hose is completely eliminated during the cutting process on a hand machine tool.

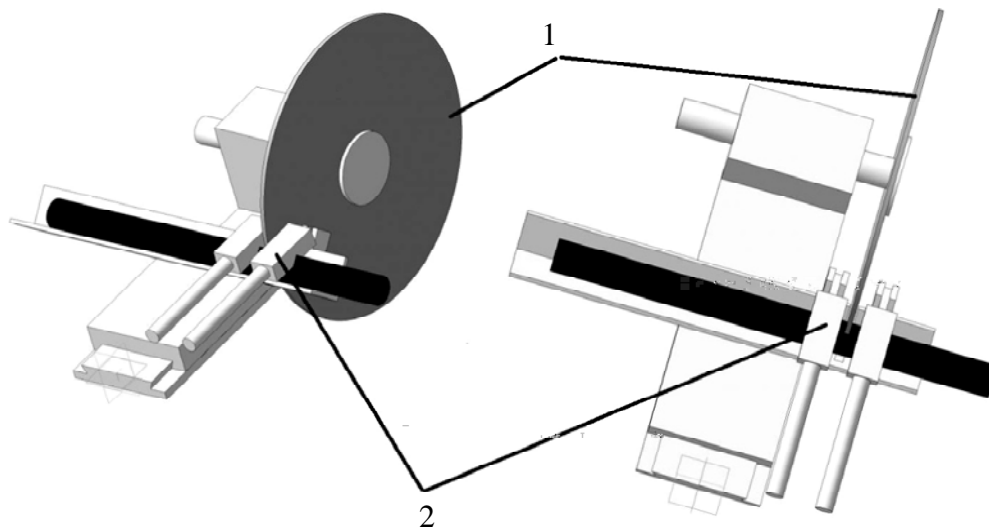

**Fig. 6.** Scheme of HPH fixing (clamping) with regard to cutting disc:  
 1 – cutting disc; 2 – hose fixers

In this case, there are some changes in the distribution of cutting forces. The vertical  $P_{yv}$  (N) and horizontal  $P_{yg}$  (N) components of cutting force may be determined with a help of the tensiometric table by the method presented in [7].

To improve the efficiency of research the multivariate experiment planning method [8] was used. This allows to reduce the number of carried out experiments in comparison with traditional methods of experiments carrying out. In Fig. 7 the scheme of loads, which acts upon the hose during its cutting, is shown. According to [9] the point of application of the resulting forces generated during the cutting is on the line connecting the centers of the disc and cut hose.

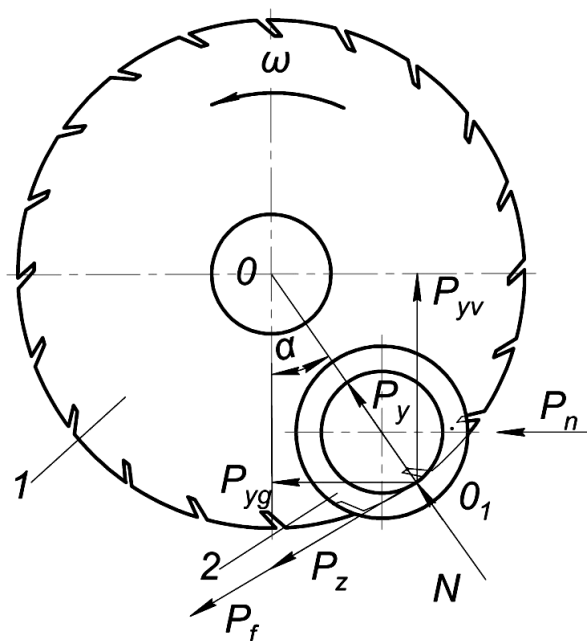

**Fig. 7.** Scheme of loads generated during the hose cutting:  
 1 – cutting disc; 2 – high pressure hose

The normal  $P_y$  (N) and tangential  $P_z$  (N) cutting forces may be determined from the following dependencies [10]:

$$\begin{aligned} P_z &= P_{yg} \cdot \cos \alpha - P_{yv} \cdot \sin \alpha; \\ P_y &= P_{yv} \cdot \cos \alpha - P_{yg} \cdot \sin \alpha, \end{aligned} \quad (1)$$

where  $P_{yg}$  is horizontal component of cutting force, N;  $P_{yv}$  is vertical component of cutting force, N;  $\alpha$  is a corner that determines the point of application of the resultant cutting force, °;

$$\alpha = \arccos \left( \frac{d_0 - d}{d_0 - d_y} \right), \quad (2)$$

where  $d_0$  is cutting disc diameter, m;  $d$  is hose outer diameter, m;  $d_y$  is hose internal diameter, m.

When determining the cutting force the values  $P_{yg}$  (N) and  $P_{yv}$  (N) obtained experimentally for maximum contact arc of cutting disc and cut hose were placed in dependence (1).

During the research it was assumed that the trajectory of any point located on the worked surface of the cutting disc, is close to the circle, as its supply rate is small in comparison with the circular one. Also, it was considered that the destruction of the worked material is carried out only due to the action of tangential forces  $P_z$  (N), evenly distributed along the contact area and related with normal forces  $P_y$  (N) by the ratio:

$$P_z = K_T P_y, \quad (3)$$

where  $K_T$  is coefficient of transformation.

The work spent on the destruction of the material (rubber and metal braid) during cutting, may be determined from the dependence [9; 10; 11]:

$$dA_0 = P_z d \tilde{l}_k, \quad (4)$$

or

$$dA_0 = q_v dV = q_v H a_c P_z d \tilde{l}_k, \quad (5)$$

where  $q_v$  is proportionality factor (energy consumption), which is determined experimentally and is equal to the work spent on the destruction of the unit volume of material;  $H$  is cutting disc height, m;  $dV$  - elementary volume of material that is destroyed, m<sup>3</sup>;  $\tilde{l}_k$  is elementary platform length along the arc of contact, m;  $a_c$  is depth of cut, m;

$$\begin{aligned} a_c &= \frac{V_n}{V_p} \int d \tilde{l}_k \sin \alpha_0; \\ \alpha_0 &= \frac{l_k}{R_0}, \end{aligned} \quad (6)$$

where  $\alpha_0$  is central angle which characterizes the size of contact area, rad.

According to the previous equations:

$$P_z = R_0 q_v H \frac{V_n}{V_p} \left( 1 - \cos \frac{l_k}{R_0} \right), \quad (7)$$

where  $R_0$  is circle radius, m;  $V_n$  is supply rate, m/s;  $V_p$  is circular speed, m/s.

The power of hand machine which is spent on the supply of the working body (cutting disk):

$$N_n = P_n V_n; \quad (8)$$

$$P_n = P_{zv} + P_{yv}, \quad (9)$$

where,  $P_{zv}$  and  $P_{yv}$  are, correspondingly, the sum of projections of tangential and normal forces on the axis, which coincides with the supply direction, (N).



The point of application of the resulting forces generated during cutting, is located on the line connecting the centers of the disc and the hose (Fig. 7). That's why, for defining of  $\alpha_0$  it is expedient to use the formula in accordance with [12]:

$$\alpha_0 = \arccos\left(\frac{R_0 - r_0}{R_0 + r_v}\right) \tag{10}$$

where  $R_0$  is the radius of cutting disc, m;  $r_0$  is hose outer radius, m;  $r_v$  is hose inner radius, m.

Taking into account (6) and (7)

$$P_{zv} = P_b \cos \alpha_0 - q_v \tilde{H} \frac{V_n}{V_p} \int_0^{\tilde{l}_k} \sin \alpha_0 \cos \alpha_0 d \tilde{l}_k; \tag{11}$$

$$P_{yv} = P_b \sin \alpha_0 - q_v \tilde{H} \frac{V_n}{V_p} \int_0^{\tilde{l}_k} \sin^2 \alpha_0 d \tilde{l}_k.$$

After integration and substitution in (8) and (9)

$$N_n = \frac{R_0}{2} q_v \tilde{H} \frac{V_n^2}{V_p} \left( \frac{\tilde{l}_k}{R_0} - \frac{1}{2} \sin 2 \frac{\tilde{l}_k}{R_0} + \sin^2 \frac{\tilde{l}_k}{R_0} \right). \tag{12}$$

As one can see  $\frac{N_n}{N} \ll 1$ , because the value  $\frac{V_n^2}{V_p}$  is rather small. That's why the power consumed for the supply of machine cutting disc may be ignored [13].

Ultimately, the normal and tangential cutting forces are as follows:

$$\begin{aligned} P_y &= P_{yv} \cos \alpha_0 + P_{zv}; \\ P_z &= P_{zv} \cos \alpha_0 + P_{yv} \sin \alpha_0. \end{aligned} \tag{13}$$

During research the dependences of tangential and normal forces on the supply rate of the free hose position and fixed one were determined using the tenzometric table and the simulation process in MathCad software. The results are presented as plots in Fig. 8.

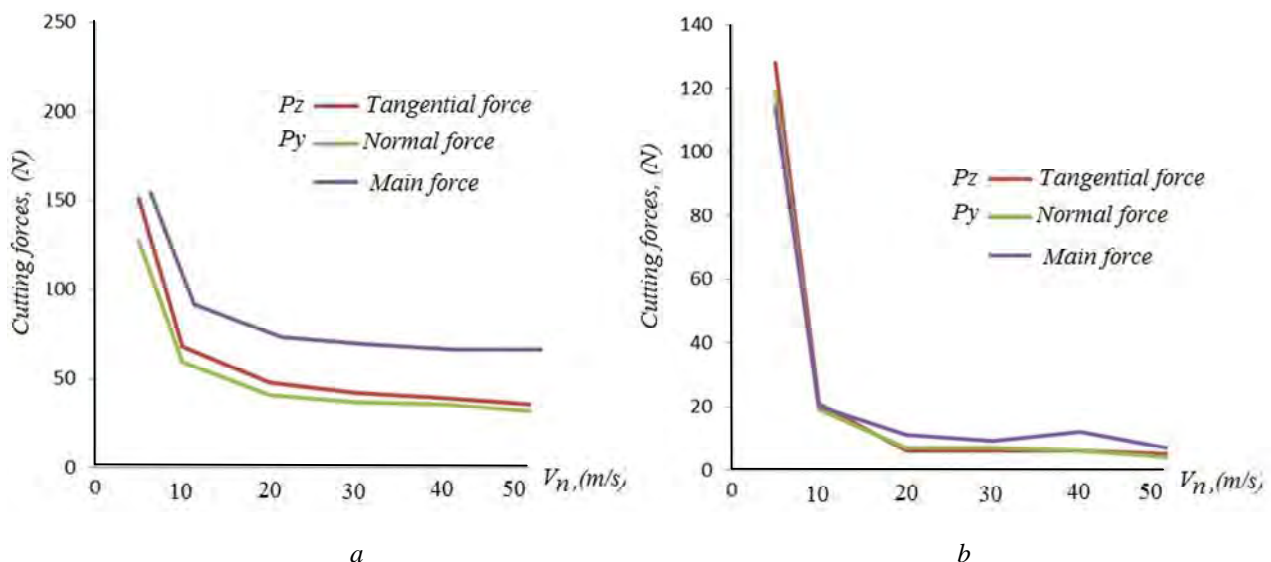

Fig. 8. Plots of cutting forces determined experimentally with a help of tenzometric table: a – free cutting; b – fixed cutting

The cut edge face of the hose meets the necessary requirements and has the form shown in Fig. 9, without the use of complicated technological processes in comparison with the previous methods.



**Fig. 9.** The edge face cuts of the high-pressure hose after fixed cutting method

The increasing of cutting speed and fixing of a hose improves the quality of edge face cuts of a hose and reduces the cutting forces up to 10–20 %. On the basis of the plots analysis, it can be concluded that the proposed method reduces the cutting forces and slightly reduces the wear of the tool.

### Conclusions

The new method of fixed cutting of high-pressure hoses on hand cutting machines is proposed. On the basis of research, the mathematical model that describes the change of tangential and normal forces depending on the process conditions of cutting on the hand cutting machine is formed for varying cutting disc speed taking into account different cutting technologies (free cutting and fixed one). The plots, which show that the usage of fixed method reduces the cutting forces are by 10–20 % in comparison with the free cutting, are presented. Fixed cutting effectively influences the energy consumptions, as well as the durability of the cutting tool. While using the proposed method the effect of subsidence and scrolling of hose is excluded resulting in the absence of loosening of the hose metal braid.

### References

- [1] Лощенов П. Ю. Способ диагностирования рукавов высокого давления // Вестник Московского государственного университета леса – Лесной вестник. – 2012. – № 3 (86). – С. 72–84.
- [2] ГОСТ-6286-73. Рукава резиновые высокого давления с металлической оплеткой неармированные. Технические условия. – Введ. 1974-07-01. – М.: Изд-во стандартов, 2003. – 16 с.
- [3] Наумов Ю. Н. Гидродинамические процессы, протекающие в гидросистемах высокого давления горных машин // Горный информационно-аналитический бюллетень (научно-технический журнал). – 2002. – № 8. – С. 24–31.
- [4] Мефедова Ю. А. Расчет рукавов высокого давления по распределению нагрузки между слоями оплетки // Вестник Саратовского государственного технического университета. – 2011. – № 2 (58), т. 3. – С. 97–102.
- [5] Tobias S., Fishwick W. Theory of regenerative machine tool chatter // Engineer. – 1958. – Vol. 205. – P. 199–203; 238–239.
- [6] Merritt H. E. Theory of self-excited machine-tool chatter, contribution to machine-tool chatter, research-1 // Transactions of the ASME, Journal of Engineering for Industry. – 1965. – Vol. 87. – P. 447–454.
- [7] Мифлиг Д. М., Семенов Е. Б., Шор Г. М. Приборы для исследования силовых параметров при шлифовании и резании камня. В сб. “Горный породоразрушающий инструмент”. – К. : Техника, 1970.
- [8] Адлер Ю. П., Маркова Е. В., Грановский Ю. В. Планирование экспериментов при поиске оптимальных условий. – М. : Наука, 1976.
- [9] Абрашкевич Ю. Д., Пелевін Л. Е., Човнюк О. В. Визначення силових параметрів процесу різання абразивними армованими кругами // Гірничі, будівельні, дорожні та меліоративні машини. – 2012. – Вип. 79. – С. 53–56.
- [10] Qin Hua, Sun Cunzhi. New method of circle and arc cutting // Optik – International Journal for Light and Electron Optics. – September 2012. – Vol. 123, Issue 17. – pp. 1550–1554.
- [11] Никулин В.В. К определению глубины реза зубками барабанных режущих органов // Изв. ВУЗов. Горный журнал. – 1966. – № 4. – С. 91–94.
- [12] Абрашкевич Ю., Рашківський В., Поліщук В., Човнюк О. Силові параметри машин з абразивним інструментом // Гірничі, будівельні, дорожні та меліоративні машини. – 2015. – Вип. 85. – С. 67–71.
- [13] Pavel A. Chentsov, Alexander A. Petunin. Tool Routing Problem for CNC Plate Cutting Machines // IFAC-PapersOnLine. – 2016. – Volume 49, Issue 12. – pp. 645–650.