

Serhii Hromniuk, Ihor Hrytsai

Lviv Polytechnic National University, Lviv, Ukraine

## CUTTER FORCE AND INFLUENCE OF ELASTIC DEFORMATION OF TECHNOLOGICAL SYSTEM OF GEAR-HOBBIING MACHINE ON PRECISION OF RADIAL-CIRCUMFERENTIAL METHOD OF GEAR CUTTING

Received: September 28, 2015 / Revised: December 12, 2015 / Accepted: December 14, 2015

© Hromniuk S., Hrytsai I., 2015

**Abstract.** The relevance of the problem which is solved in this article has been substantiated. In modern machines and equipment, rotary motions which cannot be implemented without gear wheels and gear trains are always present. Attainment of high performance of a machine – increase in loading with simultaneous increase in speed, increase in transmitted forces and moments, decrease in noise during operation, ensuring high indexes of failure-free performance and longevity of a machine – depends on precision in manufacturing the gear wheels and gear trains. These requirements to modern machines are put simultaneously with improvement of technology of their manufacturing and with creation of new effective methods of machine parts working.

A new effective method of radial-circumferential (RC) gear cutting by disk-type cutting tool under the conditions of continuous generation (revolving) around is described; this way enables us to considerably reduce the expenditures for expensive and complicated cutting tools, to increase productivity of the process, and to increase precision of gear wheels. However, for application of this method in the course manufacturing, it is necessary to develop a technique of prediction of the precision of the gear cutting; such a technique being able to serve as a basis of substantiation of the choice of regimes of gear cutting.

Principles of the mathematical model of cutting force of gear cutting, i.e. a model which is based on modelling of parameters of shearings made by a disk-type milling cutter, are presented in this article. This mathematical relation takes into account the intensity of deformation of the layer which is being removed and the strength of the material which is being machined; the model also enables us to determine the force on individual blades and its total value on all the active teeth in RC-method at any instant of time of milling as a function of the turn angle of the cutting tool. Analysis of cutting force has indicated that in one revolution of a milling cutter the cutting force varies according to aperiodic regularity, and its peak values are considerably less than the force of gear-tooth milling by a hobbing cutter under the same initial conditions.

Since the disc-type gear milling cutter, as compared with the hobbing cutter, is considerably more sensitive to elastic deformations, the cutting force can essentially influence the error of gear cutting of ring gears. Proceedings from this, the influence of primary errors and that of elastic deformations which are caused by variable cutting force in the cycle of revolution of the milling cutter and formation of gears on the error of the working is investigated. Laws of the influence of radial, axial, and torque deformations of the elastic system of a machine on the deviations of parameters of the teeth from their rated ones and on the error of profiles in the process of gear milling according to radial-circumferential method are presented. The enhance of precision of tooth cutting and reduction of the total error becomes possible due to the choice of such regimes of cutting (first of all, axial feed) under which the necessary precision of the chosen parameter of precision, in particular, profile error, can be attained.

### Introduction

Gear wheels and gearings are integral parts of drives of modern machines. The precision of manufacturing and quality of working surfaces of these machine parts determine the level of their

performance quality according to indexes of longevity and failure-free performance both of gear trains themselves and of the machine as a whole. In mechanical engineering the introduction of new structural materials of higher physical and mechanical qualities, wide introduction of superhard and superstrong and alloys into structures of machines puts requirements to improvement of existing technologies and to ensuring enhanced specifications for their manufacturing with simultaneous reduction of expenditure for their production. In the branch of technology of gear cutting (gear-tooth milling), the new radial-circumferential way of gear cutting, which is based on the use of a simple cutting tool – disk-type cutting off saw (side mill) and serial generating gear-tooth milling machines which are designed for gear cutting by means of hobbing cutters. This method is distinguished for its highest universality due to the use of a single cutting tool for different moduli gears manufacturing, widening the possibilities of conventional gear hobbers by means of which spur gears and bevel gears with straight cut and knuckle cut teeth, as well as high productivity of the process with simultaneous attaining of the gears high quality.

### **Relevance of the problem**

The conclusion that RC-method is effective has been confirmed by thorough theoretical investigations and numerous experimental data [1; 2]. However, for extensive use of RC-method, a normative basis which enable us to determine production modes and to choose rational engineering and design data of the tools and equipment must be developed. A mathematical model of the precision of the gear milling process according to RC-method [3] can serve as the basis for this purpose; the primary kinematic, geometric, and methodological errors of gear cutting being taken into account. However, in this model, errors which arise due to elastic deformations in the technological system, which is closed up at “cutting tool – workpiece” contact by the cutting force, are neglected. Alongside with this, structural materials of gears are, usually, steels and alloys with enhanced physical and mechanical qualities; due to this, the cutting force in this process can reach essential values [4], and low-thickness disk-type milling cutters are more sensitive to elastic deformation from the cutting force than hobbing cutters are. With regard for these circumstances, and proceeding from big possibilities of RC-method and from its prospect in mechanical engineering, the problem of modelling the cutting force for determination of force load and identification of the influence of this force upon the precision of the process of gear cutting by a disc-type milling cutter under the conditions of continuous generating is an urgent one.

### **Statement of purpose of research**

The aim of the work, results of which are presented in this article, consists in investigation and development of a mathematical model of cutting force, determination of primary errors which are caused by elastic deformations of elements of the technological system in RC-method of gear milling and investigation of their influence on precision of tooth cutting.

### **Theoretical part**

RC-method consists in gear cutting by a disk-type milling cutter under the conditions of continuous rotation of the workpiece under continuous motion of cutting. The method is implemented by means of a conventional hobbing generating machine, like in gear cutting with the use of hobbing cutter; the disk-type milling cutter being shifted relative to the axis of tool spindle in radial direction; the value of the shift corresponds to the modulus of the gear wheel [1; 2]. By means of altering the eccentricity without changing the milling cutter, it is possible to straight cut and spiral gear wheels of different moduli; and with certain modernization of the machine (or by means of a machine with numerical program control), bevel gears wheel and gears with circular-arc teeth can be cut with the same cutting tool.

*Modelling of cutting force.* To model the cutting force in RC-method, we proceed from the fact that the cutting process proceeds under the conditions of continuous generating, like in gear cutting by a hobbing cutter. The disc-type milling cutter, like form hobbing cutters, is a multiflute cutting tool; each tooth of the mill can perform cutting with one, two, or three of its blades; several teeth are in contact with the workpiece simultaneously, and the cutting force periodically changes with the turn angle of the cutting mill for each tooth.

The most important factor which determines the regularity of change of the cutting force is the set of the parameters of shearing. According to the basic regulation of theory of cutting, the main component of

cutting force  $P_o$  (i.e.  $P_z$ ), the vector of which coincides with the vector of cutting velocity, we present as a function of the area  $S$  of the cross-section of the cutting mill, the strength of the material machined, and the intensity of plastic deformation of the sheared layer:

$$P_z = P_\tau \cdot \cos \Phi = \tau \cdot \frac{S}{\sin \Phi} \cdot \cos \Phi = \tau \cdot S \cdot \xi, \quad (1)$$

where  $\frac{S}{\sin \Phi}$  is the area of the shear,  $\text{mm}^2$ ;  $\tau$  is the shear strength of the gear wheel material, MPa;  $\Phi$  is the angle of slide in the cutting;  $\xi$  is the chip thickness compression ratio:  $\xi = \text{ctg } \Phi \cdot \cos \gamma + \sin \gamma$  [5].

The modern method of determination of the value of the chip thickness compression ratio is based on computer modeling of the cutting process and on its rheological analysis [6–9], that enables us to find the situation of the shear plane, the angle of slide, and to calculate the value of the parameter  $\xi$ . An example of investigation of the zone of plastic deformation and of the process of chip formation on the basis of rheological analysis in titanium alloy cutting is given in Fig. 1. According to the results of modeling for certain initial conditions, which are presented in Fig. 1, the slide angle equals  $38^\circ$ , and for the face angle  $4.5^\circ$ , the chip thickness compression ratio equals 1.35

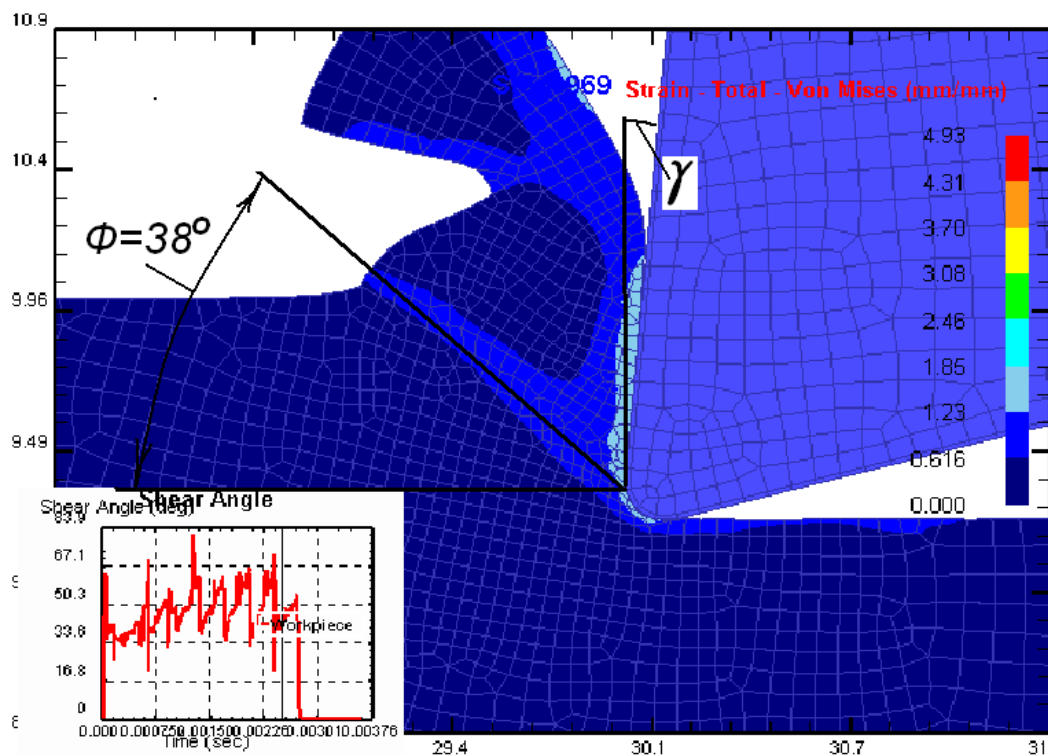

Fig. 1. Region of plastic deformation in cutting

The parameter  $\tau$  is a function of the ultimate stress  $[\sigma]$ ; according to the theory of greatest tangential stresses (third theory of strength),  $\tau = \frac{[\sigma]}{2}$ .

Parameters of shearings depend on many factors depend on many factors – axial feed (advance), diameter of the mill, number of its teeth, modulus of the cuted gear wheel, sizes and configuration of the transitive surface of cutting, in which the milling cutter works, depends on combination of these factors. the technique of determination of the area of the cross-section, of the thickness and width of the shearing in RC-method is presented in the work [10].

In Fig. 2, an example of determination of the force of cutting by a disk-type milling cutter in cutting of hardened gear wheels of 1–1.75 mm modulus. the forces are determined for the turn angles of the front

surfaces of teeth where the thickness of shearing is maximal, which corresponds to their maximal values; the average value of cross-section areas of shearings and the average values of forces of cutting over the length of the contact arc are 9–10 times greater than the maximal ones. In Fig. 2, *a*, the maximal lateral forces, which acts on an input blade of a disk-type milling cutter at different axial feeds (advances) are shown; and in Fig. 2, *b*, the change of the total force at all the blades of teeth which perform cutting simultaneously.

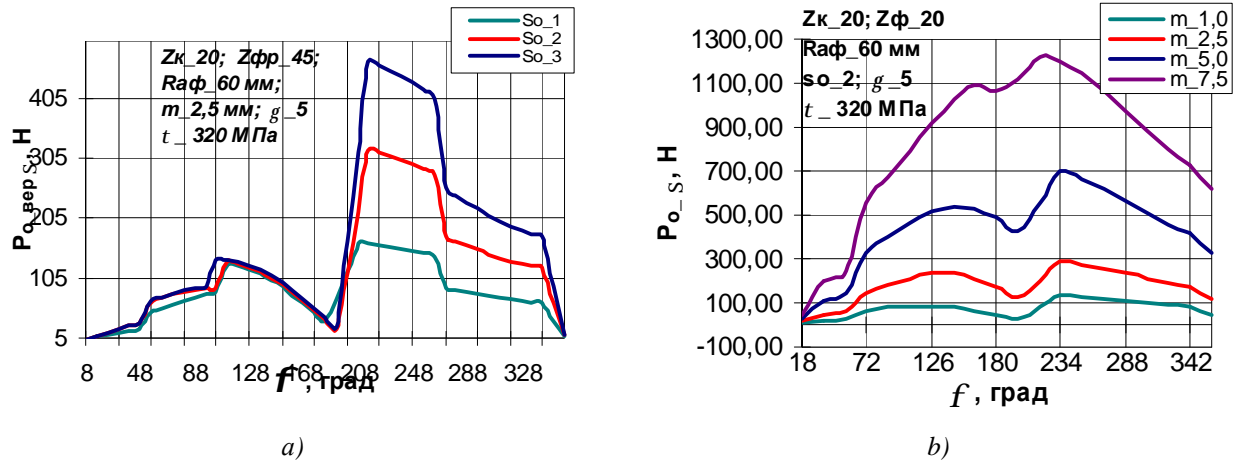

Fig. 2. Cutting force at points of blades (*a*) and total cutting force (*b*) over one revolution of hobbing cutter with change in axial feed (*a*) and in modulus of cuted gear wheel (*b*)

As a function of parameters of shearings, the cutting force of a disk-type milling cutter varies during one revolution with the eccentricity variation, since the instant of cutting-in till the instant of cutting-off. The instantaneous total force which acts on a cutting tool at every instant of time of cutting is equal to the vector sum of the forces on all the teeth of the milling cutter which are simultaneously in contact with the workpiece. Under the action of such force, a disc-type milling cutter is subjected to variable deformation with respect to all the axes, that influences the quality and precision of the gear wheel.

The forces which act upon a cutting tool and upon a workpiece in middle part of a gear wheel under the axial feed (advance)  $s_o$  of the milling cutter and under the eccentricity  $e$  are given in Fig. 3. The cutting force  $R$  is presented by means of the projections  $R^I$ ,  $R^{II}$  and  $R^{III}$ , and its technological components in the coordinate system of the machine by the forces  $P_x$ ,  $P_y$ ,  $P_z$  [11].

*Elastic deformations in technological system.* Deformation of a milling cutter in the direction of its axis is caused by the force  $P_z$  of cutting by input lateral blades; the same force creates a torque about the axis of the table. Deformation of the system in the radial direction is caused by the force  $P_y$ ; and in axial direction by the force  $P_x$ .

The elastic deformations which emerge in the plane of a milling cutter in the radial direction are not essential, since the milling cutter in this case is of high rigidity.

*Elastic deformations of milling cutter in axial direction.* As a result of the action of the lateral force in the direction of the axis of a milling cutter (the force  $P'_{y_{ax}}$  emerges due to shearing of part of envelope of metal by lateral input blades and corresponds to tangential wheel tangent line component  $P_z$ ), a milling cutter experiences actions of the elastic deformation  $\Delta x_{xJ}$ ; its intensity periodically changes during one revolution of the milling cutter.

According to basic principles of strength of materials, we consider the disk-type milling cutter as a solid which is rigidly restrained in the region of its contact with the shaft [12; 13].

The elastic deformation  $\Delta x_{xJ}$  of the milling cutter, as a bending deflection at its outer diameter  $R_a$ , that is caused by the force  $P_z$ , we determine from the relation:

$$\Delta x_{xJ} = \frac{P_z \cdot R_a^3}{3 \cdot E \cdot j}, \text{ mm}, \quad (2)$$

where  $j$  is the moment of inertia of the disc of the milling cutter with respect to the neutral axis;  $E$  is the modulus of elasticity of the metal; for hardened steels  $E = 3,4 \cdot 10^5$  MPa. As the force is applied in the

region of outer radius of the milling cutter, the moment of inertia must be determined for half the area of the milling cutter. For the milling cutter's thickness  $b$ , the moment of inertia is the following:

$$j = \pi \cdot R_a^3 \cdot b, \text{ mm}^4, \quad (3)$$

and with taking into account this expression the deformation of the milling cutter in axial direction becomes the following:

$$x_\omega = 3,2 \cdot 10^{-4} \cdot \frac{P_z}{b}, \text{ mm}. \quad (4)$$

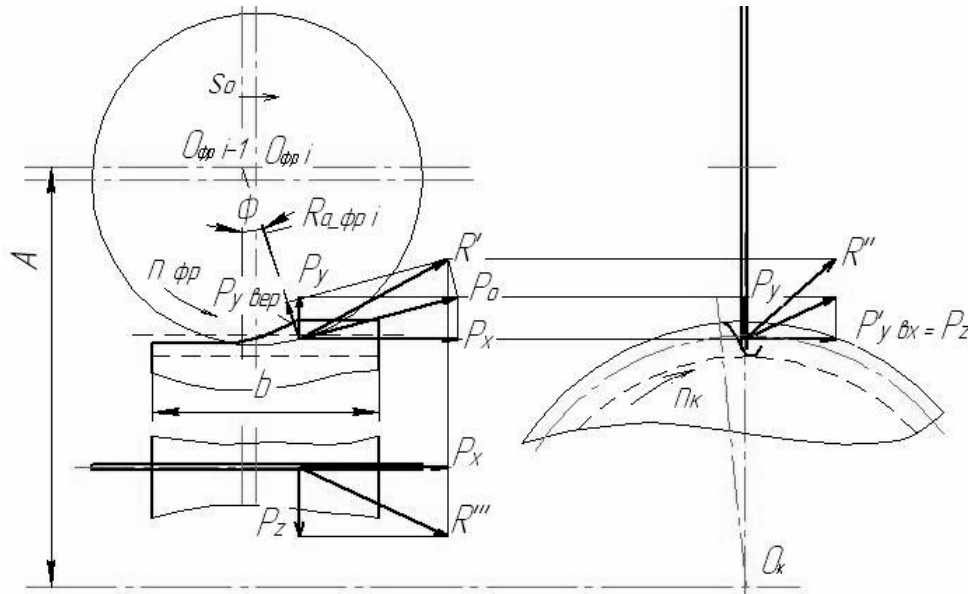

Fig. 3. Forces which act on disk-type milling cutter and gear wheel in process of gear cutting by RC-method

In Fig. 4, the variation of axial elastic deformation of a disc-type milling cutter as a function of its turn angle is presented for cutting one gash between teeth when the thickness of the disc-type milling cutter equals 2.5 mm.

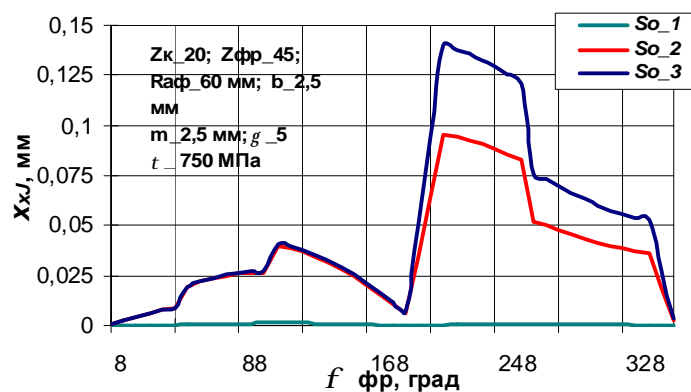

Fig. 4. Elastic deformation of milling cutter depending on its turn angle in axial direction when one gash is being cuted

Due to elastic deformation of a milling cutter, the rated profile of the gear wheel in the direction of the coordinate  $x$  changes. The error which arises due to this can be presented by the system of equations:

$$\begin{cases} x = (R_{\omega-k} + \Delta x_\omega + e \cdot \cos \varphi) \cdot \cos \frac{\varphi}{Z_k}; \\ y = -(R_{\omega-k} + e \cdot \cos \varphi) \cdot \sin \frac{\varphi}{Z_k}. \end{cases} \quad (5)$$

The actual and reference profiles which are formed as a result of axial deformations of the milling cutter are shown in Fig. 5.

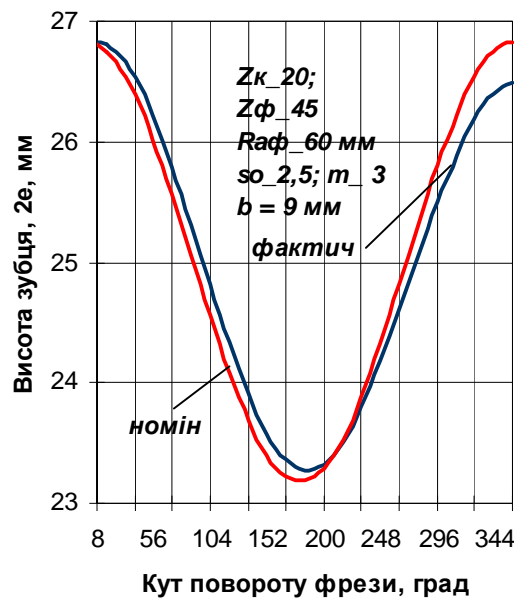

Fig. 5. Change of tooth profile due to cutting with axial deformation of milling cutter

Torque deformations on axis of machine table. During cutting an oblique-spur gear wheel with the angle  $\beta$  of inclination, in addition to the force  $P_z$ , the projection of the force  $P_o$  onto the tangential axis – the force  $P_{z_k}$  – acts upon the wheel (Fig. 6). Even if the action of the force  $P_z$  upon the wheel with the machine table is inessential due to low value of the areas of shearings on input blades, the force  $P_{z_k}$  can cause considerable deviations in the regularity of machine table rotation with the workpiece, and tangential errors in tooth cutting take place.

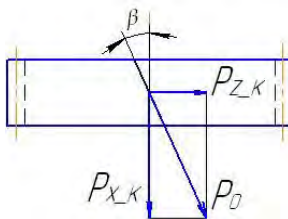

Fig. 6. Components of cutting force in oblique-spur gear cutting

If the torque rigidity of the machine table with the installed on it device and with the workpiece equals  $G$ , Nm/rad, the tongue deformation (torsion) of the table, which determines the error of generating, is determined by the formula:

$$\Delta j = \frac{M}{G} = 10^{-3} \cdot \frac{P_o \cdot \cos \phi \cdot \sin b \cdot m \cdot Z_k}{2 \cdot G}, \text{ rad}, \quad (6)$$

where  $m \cdot Z_k = D_{\omega_k}$  is the pitchline diameter of the gear wheel, mm;  $\phi$  is the angular situation of the front surface of the  $i^{\text{th}}$  tooth of the milling cutter which corresponds to the maximal depth of cutting in conformation with the angle of contact of the tooth [14].

The torque rigidity of gear-milling machines of normal precision, depending on maximal diameter of the cuted wheel, is from 200 to 500 Nm/rad. The torque elastic deformations act periodically at the frequency equal to that of teeth, and their variation within one gash between teeth of the wheel proceeds according to the regularity of change of the force  $P_o$ . In Fig. 7, the reference profile and a profile which emerges due to an error (6) are shown. For example, at an axial feed (advance) of 1 mm/revolution, at a

torque rigidity of the machine table of  $G = 300 \text{ Nm/rad}$ , and at an angle of  $25^\circ$  of teeth inclination of an oblique-spur wheel, the maximal deviation of profiles is equal to  $0.3261 \text{ mm}$ .

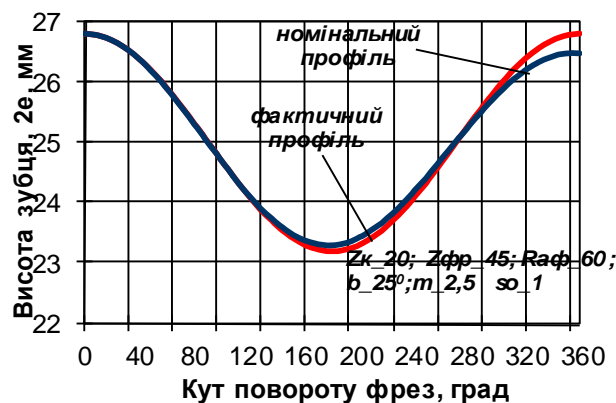

Fig. 7. Change of tooth profile of cuted wheel due to torque deformation on axis of machine table and axis of wheel

In Fig. 8, an error of profile due to the action of the torque moment on the axis of the wheel and at an axial feed (advance) of  $1.2$  and  $3 \text{ mm/revolution}$  is shown; the errors of cutting are presented for left and right system of profiles with taking into account the fact that in the first half-revolution of the milling cutter, left profiles are formed, and in the second half-revolution right profiles of the wheel are formed.

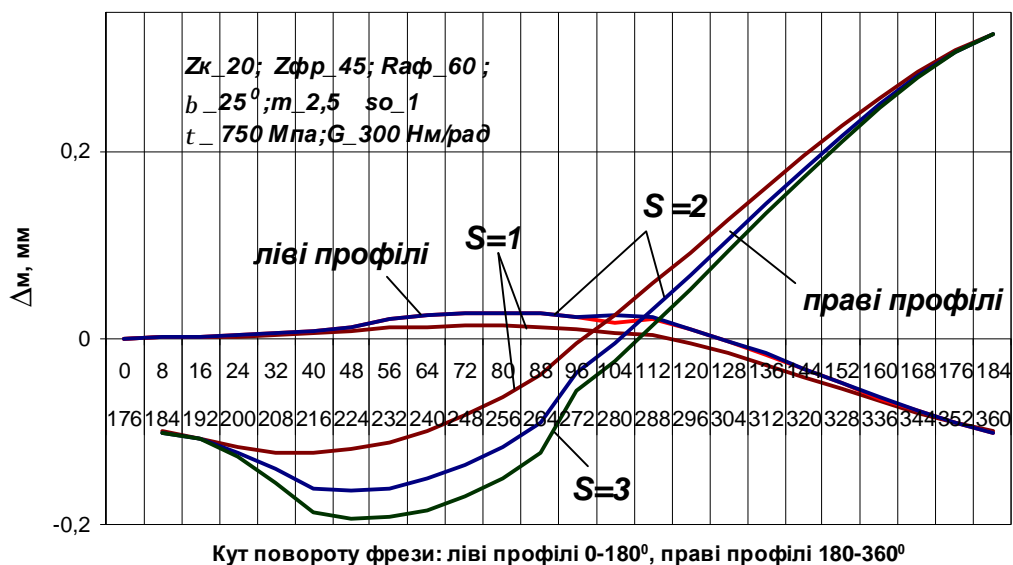

Fig. 8. Error of profiles of teeth due to elastic torque deformations on axis of machine table

### Conclusions

Urgency of the solved problem and prospects of radial-circumferential method of continuous gear milling for production of gear wheels has been proved.

A formula for calculation of the cutting force of gear-tooth milling in manufacturing spur gear wheels depending on areas of shearings, strength of the material machined, and intensity of deformation of cutting. The calculated values of the cutting force are by an order less than the cutting force of cutting by hobbing gear cutter., that ensures higher precision of gear cutting according to RC-method.

The presentation of the force in the form of a function of parameters of the shearings, which vary with the turn angle of the milling cutter, enables us to represent the variable force loading and the elastic deformations which are caused by pulsing cutting force in the system of a gear-hobbing machine.

The influence of primary factors on the error of profiles of the cutted gear wheels, which a reason for choosing the regimes of cutting in order to control the caused by the error elastic deformations and to reduce the error of cutting.

Since the cutting force is a function of parameters of shearings and of regimes of cutting, it is possible to influence the cutting force and to ensure such a value of elastic deformations at which the requirements to the precision of gear wheels will be observed; this is to be done by the corresponding change of working regimes.

### References

- [1] Грицай І. Є., Литвиняк Я. М. Підвищення техніко-економічної ефективності процесів виробництва зубчастих коліс поєднанням традиційних та нових способів формоутворення. Вісник Національного університету “Харківський політехнічний інститут” : зб. наук. пр. – № 26. – Харків : Вид-во НТУ “ХПІ”. – 2010. – С. 30–35.
- [2] Грицай І. Є. Стан і перспективи в галузі зубчастих передач і технології зубообробки // *Машиностроение и техносфера XXI века : Сборник трудов XIX Международной научно-технической конференции.* Севастополь, 17–22 сентября 2012 г. : в 3-х т.: Т 3. С. 202–209.
- [3] Громнюк С. І., Грицай І. Є. Моделювання складових сумарної похибки і точності зубчастих коліс в радіально-коловому способі зубонарізання // Вісник НТУ “Харківський політехнічний інститут”. Серія “Проблеми механічного приводу”. – № 31 (1074): – Харків : НТУ “ХПІ”, 2014. – С. 24–28.
- [4] Hromniuk S., Hrytsaj I. The study of the cutting force and its components in radial-circular cutting of the gears // *Оптимізація виробничих процесів і техн. контроль у машинобудуванні та приладобудуванні.* – № 786. – Львів : Вид-во Львівської політехніки. – 2014. – С. 61–67.
- [5] Розенберг А. М. Механика пластического деформирования в процессах резания и деформирующего протягивания. – К. : Наукова думка, 1990. – 320 с.
- [6] Stupnytskyy V. New features CAD/CAM/CAE systems in mechanical engineering / V. Stupnytskyy // *Europäische Fachhochschule: Wissenschaftliche Zeitschrift, ORT Publishing.* Stuttgart, 2012. – № 1. – P. 327–329.
- [7] Ступницький В. В. Моделювання процесу різання в автоматизованій системі інженерного аналізу DEFORM 2D / В. В. Ступницький // *Український міжвідомчий науково-технічний збірник “Автоматизація виробничих процесів у машинобудуванні та приладобудуванні”.* – 2012. – № 46.– С. 141–144.
- [8] Stupnytskyy V. Computer Aided Machine-Building Technological Process Planning by the Methods of Concurrent Engineering / V. Stupnytskyy // *Europäische Fachhochschule: Wissenschaftliche Zeitschrift, ORT Publishing.* 2013. Stuttgart. № 3 (Maart). Section 1. – Vol. 2. – P. 50–53.
- [9] Stupnytskyy V. Features of Functionally-Oriented Engineering Technologies in Concurrent Environment / V. Stupnytskyy // *International Journal of Engineering Research & Technology (IJERT).* – 2013. – Vol. 2, Issue 9. – P. 1181–1186.
- [10] Грицай І. Є., Громнюк С. І., Кук А. М. Параметри поперечного перерізу зрізів в радіально-обкочувальному способі нарізання зубчастих коліс з осьовою подачею // Вісник Нац. ун-ту “Львів. політехніка” Оптимізація виробничих процесів і техн. контроль у машинобудуванні та приладобудуванні. – № 772. – Львів. – Вид-во Львівської політехніки. – 2014. – С. 8–14.
- [11] Hromniuk S., Hrytsaj I. The study of the cutting force and its components in radial-circular cutting of the gears // *Оптимізація виробничих процесів і техн. контроль у машинобудуванні та приладобудуванні.* – № 786. – Львів : Вид-во Львівської політехніки. – 2014. – С. 61–67.
- [12] *Справочник по сопротивлению материалов / Г. С. Писаренко, А. П. Яковлев, В. В. Матвеев.* – К. : Наук.думка, 1988. – 736 с.
- [13] *Справочное пособие по сопротивлению метериалов / М. Н. Рудицин, П. Я. Артемов, М. И. Любошиц.* – Минск, 1968. – 510 с.
- [14] Грицай І. Є., Громнюк С. І., Кук А. М. Параметри поперечного перерізу зрізів в радіально-обкочувальному способі нарізання зубчастих коліс з осьовою подачею // Вісник Нац. ун-ту Львівської політехніки Оптимізація виробничих процесів і техн. контроль у машинобудуванні та приладобудуванні. – № 772. – Львів : Вид-во Львівської політехніки. – 2014. – С. 8–14.