

## MODELING THE RADIATION FIELD OF A SLOT ANTENNA IN A FINITE SIZE SCREEN

Viktor Hoblyk, Oleksiy Liske

Lviv Polytechnic National University, Ukraine  
viktor\_hoblyk@mail.ru

© Hoblyk, V., Liske, O., 2013

**Abstract:** A radiating structure based on a slot line has been investigated using a decomposition method in combination with the concept of induced electromotive forces. The influence of the size of a screen on the distribution of surface currents has been analyzed. Co- and cross-polarized radiation patterns of a slot rhombic antenna have been computed. It has been found that the slot rhombic antenna has broadside radiation in the 1.85-2.8 GHz frequency band. The radiation pattern and voltage standing-wave ratio (VSWR) of the constructed slot rhombic antenna have been measured.

**Key words:** rhombic slot antenna, slot line, method of induced electromotive forces.

### 1. Introduction

Research into the electrodynamic characteristics of radiating structures based on slot lines is an important task being the base for creating new radiators with specified parameters. The potential possibility of radiating electromagnetic energy by slots in cylindrical metal plates was first mentioned in [1], and the theory of such radiators was developed in [2]. The idea of using a small round hole or a small rectilinear slot on the surface of an electric resonator with a high-frequency electromagnetic field being excited was described in [3]. Electromagnetic waves radiate through the hole of the resonator referred above so that it turns into an antenna called diffractive due to the phenomenon of diffraction on the hole in a receive mode, or a so-called slot antenna, because the holes in the screen have usually the shape of narrow slots.

Slot antennas meet the requirements of various departments related to the electromagnetic radiation, and it causes their wide application. These types of antennas are used in the range of millimeter - decimeter waves as embedded antennas in the integrated circuits of aircraft antenna systems and missile guidance systems, mobile communications, biological telemetry, flexible applicators for radiofrequency physiotherapy and microwave planar reflective sensors for material humidity testing [4-6]. Slot radiators with circular polarization are designed [7-9].

Developing multifrequency slot antennas for the use in wireless communication systems was a problem considered in [10].

In [11] it was shown that a quasi-TEM (quasi transverse electric and magnetic) wave is transmitted by the two wires of a slot line. The characteristic impedance of the slot line can be controlled by varying the width of the slot. The shape and the geometry of the slot line play an important role in changing the electrodynamic characteristics of the structure.

One of the advantages of the slot antenna is the simplicity of excitation [3]. Usually the power supply of the slot antenna is provided by two-wire feed [12, 13] or coplanar line (CPL). Application of a CPL extends the operating frequency band, improves impedance matching and simplifies integration with solid active devices [5, 14]. Equivalent magnetic currents in both slot lines of the CPL at a quasi-TEM mode radiate in an opposite phase reducing to zero a cross polarized field component [5]. The use of the CPL makes it possible to create antenna arrays by connecting several slot radiators of complex shape [14].

In the early stages of the development of this theory slot line antennas were considered in approximation to a slot, cut in an infinite screen. For the problem of slot excitation and the calculation of the radiation field A.A. Pistolkors formulated the principle of duality [15]. The radiation of the slot antenna can be defined as the radiation of a fictitious "magnetic current" that flows over the screen along the slot. Therefore, these radiators are called magnetic. To find the equivalent magnetic currents in the slot antenna of a closed form that is commensurate to the wavelength the full wave method of moments was used [7].

The electric field distribution in the slot can be obtained from the relationship between the slot and a complementary wire antenna [13]. It was found that the electric field distribution (magnetic current) in the slot cut in an infinite electroconducting screen is identical to the electric current distribution on a complementary wire [16]. This approach was used in [6] to calculate the field of an annular slot antenna. In that paper the annular distribution of magnetic surface current flowing in the infinite screen was chosen as the antenna model. For different distributions of the electric field in the slot and the different sizes of the ring, the features of radiation pattern were revealed.

In [17] the calculation of a broadband curved slot radiator, whose model is an infinitely thin radiator of the same shape as the slot with a specified amplitude-phase voltage distribution along it, was presented. The external problem of designing the antenna with a cardioid radiation pattern was reduced in that paper to solving the Euler equation. To determine an optimal amplitude-phase voltage distribution in an elliptical slot radiator the Euler equation using grid functions was transferred to the system of linear equations. The third iteration of the computation procedure for these equations gives the solution with the accuracy up to  $10^{-4}$ . In [10] it was shown that the high accuracy of single slot radiator analysis can be achieved by a transmission line method, which in addition is quite simple.

Recently a number of commercial high-frequency simulation tools for the numerical calculation of electromagnetic fields were proposed. Those tools are usually based on one of the following numerical techniques: finite-difference time-domain method, method of moments, finite element method [18].

Surfaces on which slot lines are placed have actually finite sizes and are irregular in shape. It is not possible to obtain a rigorous solution to the electrodynamic problem, and approximate solutions suitable for engineering practice need to be developed.

This paper presents the results of developing the method of investigating the electromagnetic characteristics of the radiating slot line in the infinitely thin conducting plate of a limited size.

## 2. Model of a slot rhombic antenna

The geometry of a slot rhombic antenna (SRA) is shown in Fig. 1a. A metal sheet with a rhomb-shaped slot line is covered with a dielectric layer of thickness  $d$  with a relative dielectric permittivity  $\varepsilon_r$ . The slot line is located symmetrically with respect to the  $y$ -axis.

The distribution of the current on the metal surfaces is calculated by a decomposition method. The essence of this method is as follows: 1) the metal sheet is replaced by an unknown surface current density  $J(x, y) = J_x \hat{x} + J_y \hat{y}$ ; 2) the conducting surface is represented as a double-array of  $N$  vertical and  $M$  horizontal infinitesimally thin dipoles which are much smaller than the wavelength,  $L \ll \lambda$ , located at a distance  $\Delta l$  from each other; 3) current distribution along the dipoles is harmonious; active dipoles are located along the slot line (Fig. 1, b) and fed in the center of  $\delta$ -gap by voltage, whose distribution law is typical for a long line with losses in the mode determined by a load impedance.

To give an example the following parameters have been chosen for the geometry shown in Fig. 1a. The metal surface is defined as perfectly conducting layer of infinitesimally small thickness, the perimeter of the rhombic slot is  $L_s = 2 \cdot \lambda_s$ , the slot width is  $w = 1.5$  mm, the dielectric substrate height is  $h = 1.5$  mm, relative permittivity of dielectric substrate is  $\varepsilon_r = 3.5$ .

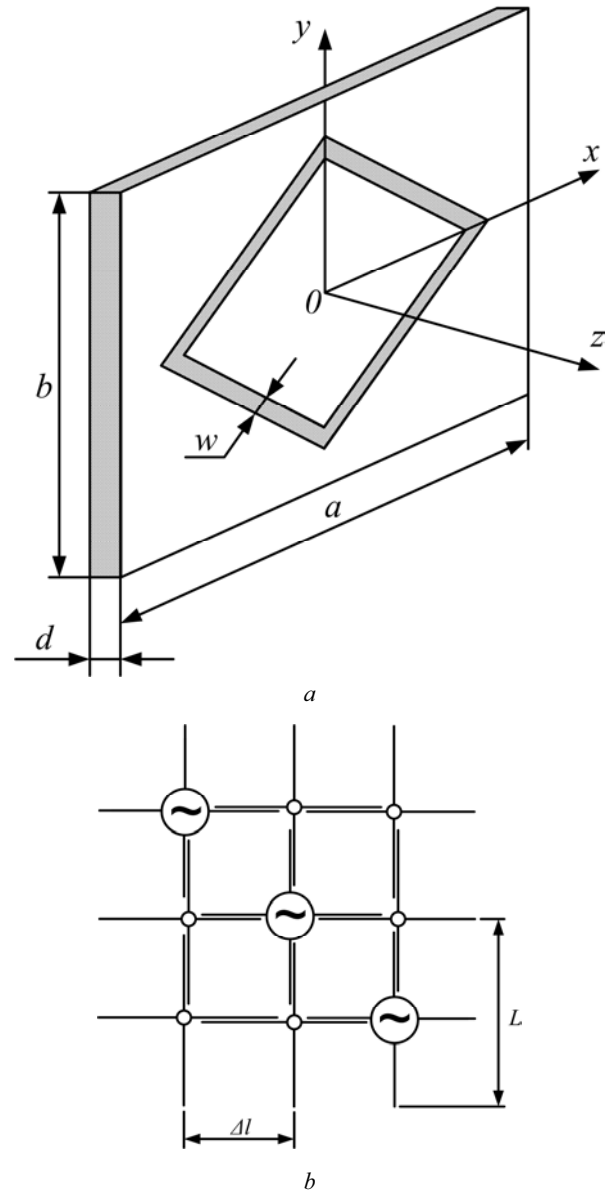

Fig. 1. Slot rhombic antenna geometry (a) and its model (b).

The finite size of the dielectric substrate, on which the metal screen is located, has a significant influence on the slot line wavelength  $\lambda_s$ . The value of the wavelength necessary for the accurate determination of voltage distribution for the given  $w/h$  ratio is obtained using the closed-form expression described in [19].

The field in the slot line differs significantly from the wave of  $T$  type. The field in the slot line has a longitudinal magnetic field component  $H$  and it is actually an  $H$  type wave. Those lines can transmit waves of any frequency up to  $f = 0$  [16].

The magnitudes of unknown dipole current densities are calculated from the known mutual coupling matrix and the distribution of dipole feeding voltages. The calculation is carried out by the method of induced electromotive forces using the system of linear equations:

$$\begin{bmatrix} Z_{11}, Z_{12} \dots Z_{1m} \\ Z_{21}, Z_{22} \dots Z_{2m} \\ \vdots \\ Z_{n1} \dots Z_{nm} \end{bmatrix} \cdot \begin{bmatrix} I_1 \\ I_2 \\ \vdots \\ I_n \end{bmatrix} = \begin{bmatrix} U_1 \\ U_2 \\ \vdots \\ U_n \end{bmatrix}. \quad (1)$$

Fig. 2 shows the distribution of the module of the vertical and horizontal components of the surface current on the screen with a rhombus slot line.

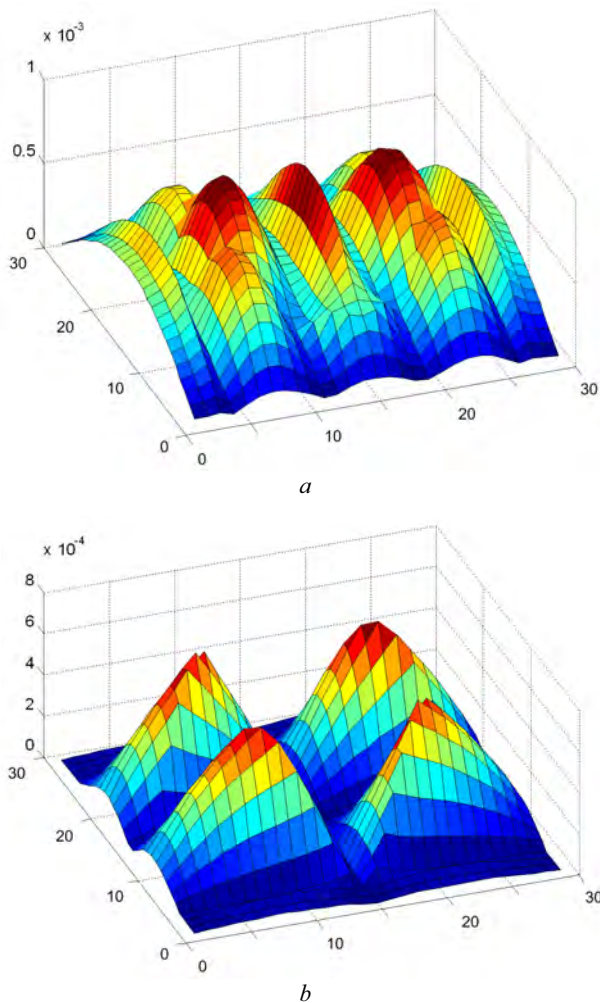

Fig. 2. The amplitude of vertical (a) and horizontal (b) dipole currents.

The size of the screen is 87×87 mm and the number of vertical and horizontal dipoles equals 900.

The sum of these components shows the distribution of SRA surface currents.

The influence of the size of the metal screen on the distribution of the surface current is illustrated in Fig. 3.

From the Fig. 3 we can observe that if the size of the screen expands in one direction, the surface currents parallel to the longer side of the screen are excited. The transverse component is concentrated within the slot.

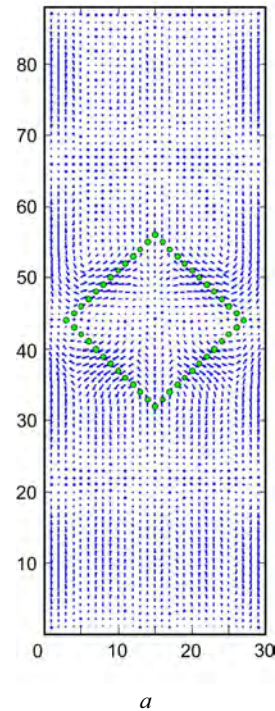

a

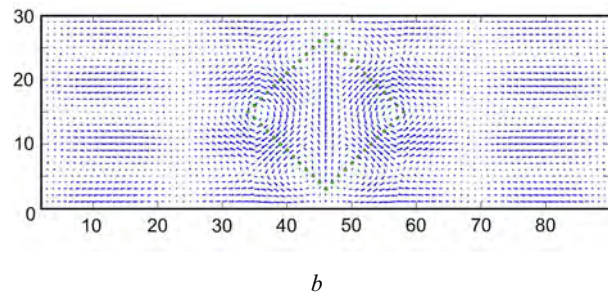

b

Fig. 3. The distribution of surface currents of the slot in vertical (a) and horizontal (b) screens.

On the basis of the obtained current density the far field radiated by the planar array of dipoles is calculated. It is done in accordance with the principle of pattern multiplication, i.e., the pattern of one element is multiplied by the array factor (AF). The AF is given by

$$\dot{f}(\theta, \varphi) = \sum_{i=1}^N A_i \cdot e^{j(\Phi_i + k\rho_i \cos \gamma_i)}, \quad (2)$$

where  $N$  is the number of dipoles;

$A_i$  and  $\Phi_i$  are amplitude and phase distribution in the array respectively;

$\rho_i$  is the distance from the origin to the  $i$ -th element of the array;

$\gamma_i$  is the angle between the directions from the origin to the  $i$ -th element and to the observation point;

$k$  is the wave number.

On the basis of the found currents the radiation patterns of the SRA have been calculated by means of MATLAB software at the frequency of 2.4 GHz (Fig. 4) in the  $E$ - and  $H$ -planes.

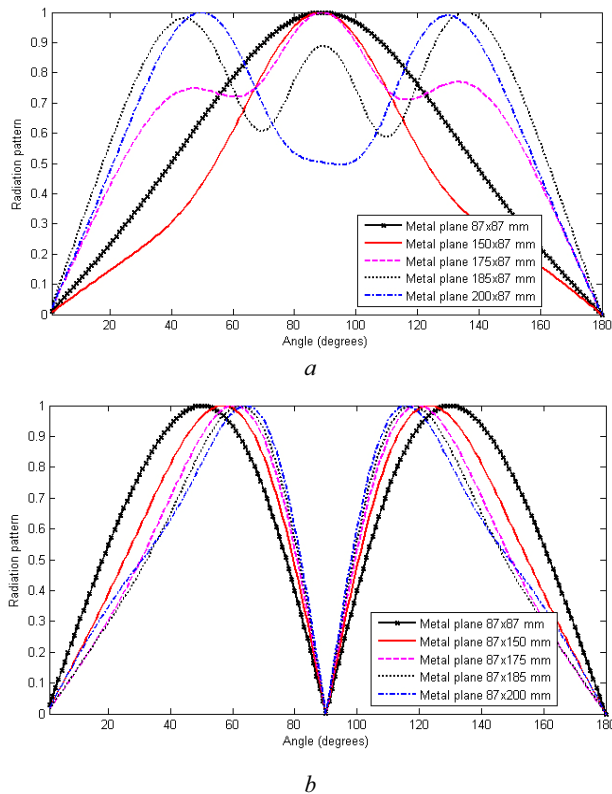

Fig. 4. The radiation patterns of the SRA: a) copolarization in YOZ plane, b) crosspolarization in XOZ plane.

For the given geometry of the slot line the symmetry preservation of the radiation pattern for vertical polarization in the YOZ vertical plane is observed, while changing the vertical size of the screen. As well, increasing the size of the screen leads to the gradual split of the radiation pattern, caused by the presence of oppositely directed surface currents. When changing horizontal size of the screen, the symmetry of the radiation pattern with respect to the YOZ plane for all screen sizes is preserved owing to the antiphase feeding of radiator arms.

By multiplying the radiation pattern in the  $E$ -plane and  $H$ -plane, 3D radiation patterns have been obtained for the vertically polarized field over the wide frequency range (Fig. 5-9). The effect of the electrically thin dielectric substrate on the backward radiation has been neglected. In the frequency range from 1.85 GHz to 2.8 GHz, the vertically polarized radiation with minimal side lobes normal to the plane of the radiator is observed. The gain obtained at 2.4 GHz is  $G = 4.88$  dB. Owing to the symmetric structure of the radiator the symmetry of the horizontally polarized radiation pattern is observed in the absence of radiation in the YOZ plane (Fig. 10-14).

### 3. Evaluation of decomposition method

To evaluate the accuracy and speed of the calculation of electrodynamic characteristics of the antenna, the simulation of the slot radiator (Fig. 1) has

been carried out. Three different 3D electromagnetic field stimulation softwares have been used: Microwave Office performing calculations using the method of moments, Ansoft HFSS using the finite element method and CST Microwave Studio using the finite-difference time-domain method.

The simulation results are presented in Table 1.

Table 1

#### The results of SRA simulation performed by means of three softwares

CST Microwave Studio		
	Transient solver	Frequency domain solver
Accuracy limit	-30 dB	0.001
Mesh	76,160 hexahedral cells	123,491 tetrahedrons
Simulation time	1:02	34:32
Ansoft HFSS		
Accuracy limit	0.0033	
Number of Passes	20	
Mesh	132,002 tetrahedrons	
Simulation time	1:08:11	
Memory	1.13 GB	
AWR Microwave Office		
Dimensions of cells	1.36x1.36 mm	
Simulation time	12:05	
Memory	82MB	

The results confirm that for analyzing microstrip structures the method of moments is the most efficient technique among those used in commercial high-frequency simulation softwares for the numerical calculation of electromagnetic fields.

Using the developed decomposition method, calculation results have been obtained in 4 iterations within 22 seconds, herewith the number of dipoles in the antenna array is 1521. This result indicates that the method mentioned above does not require high computational resources and has a sufficiently high processing speed in comparison with full-wave 3D electromagnetic simulation tools.

To evaluate the accuracy of the numerical techniques the comparison of the obtained simulation results with experimental results is shown in Fig. 15.

An experimental SRA has been designed and constructed in a conductive screen of size 87x87 mm. The geometry, mode and specifications of the slot rhombic antenna are described in section 2. The SRA is fed by a coaxial feeder.

For comparison, Fig. 16 presents the  $E$ - and  $H$ -plane radiation patterns of the SRA, obtained by the way of simulation and through experimental measurements at the frequency of 2.4 GHz in short-circuit conditions. There is a clear correspondence between theoretical and experimental results indicating that the proposed method is appropriate for slot radiating structures.



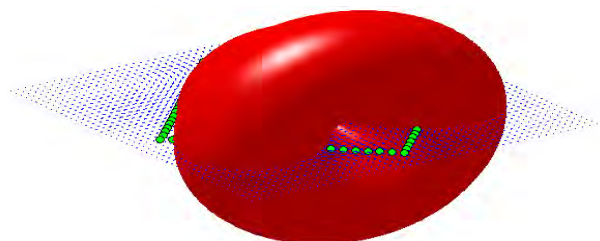

Fig. 5. Radiation pattern at the frequency of 1.25 GHz, vertical polarization, maximum gain = 3 dB.

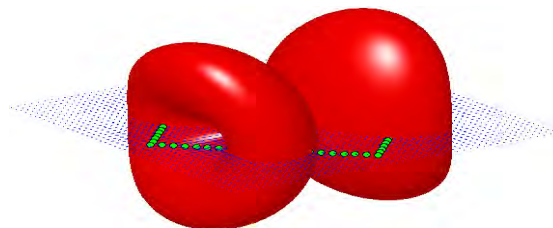

Fig. 10. Radiation pattern at the frequency of 1.25 GHz, horizontal polarization.

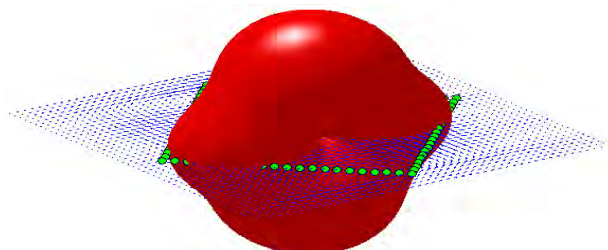

Fig. 6. Radiation pattern at the frequency of 1.85 GHz, vertical polarization, maximum gain = 4.15 dB.

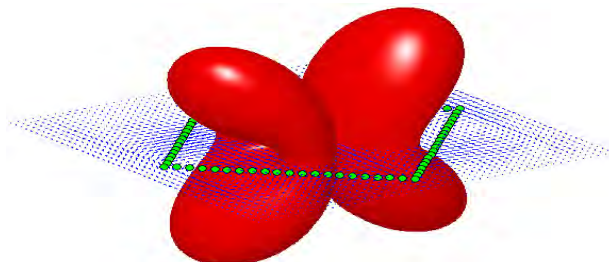

Fig. 11. Radiation pattern at the frequency of 1.85 GHz, horizontal polarization.

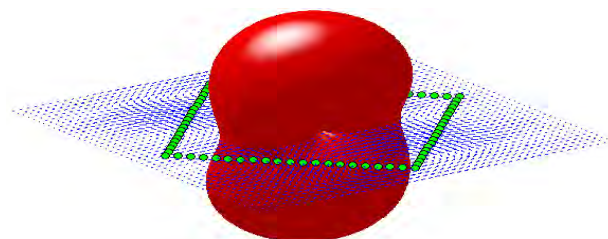

Fig. 7. Radiation pattern at the frequency of 2.4 GHz, vertical polarization, maximum gain = 4.88 dB.

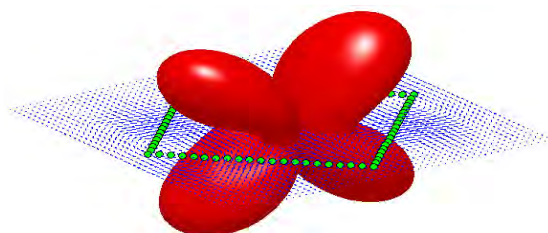

Fig. 12. Radiation pattern at the frequency of 2.4 GHz, horizontal polarization.

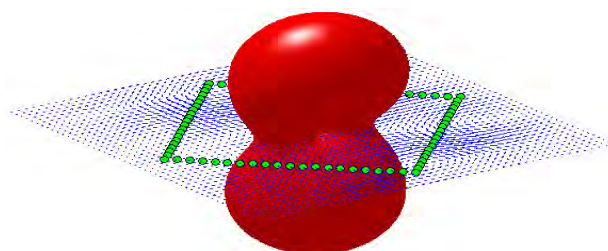

Fig. 8. Radiation pattern at the frequency of 2.8 GHz, vertical polarization, maximum gain = 6 dB.

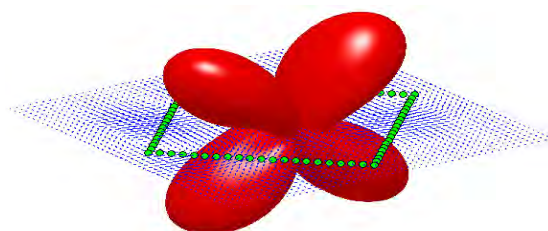

Fig. 13. Radiation pattern at the frequency of 2.8 GHz, horizontal polarization.

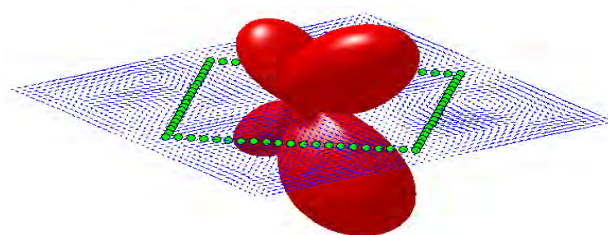

Fig. 9. Radiation pattern at the frequency of 3.4 GHz, vertical polarization, maximum gain = 8.6 dB.

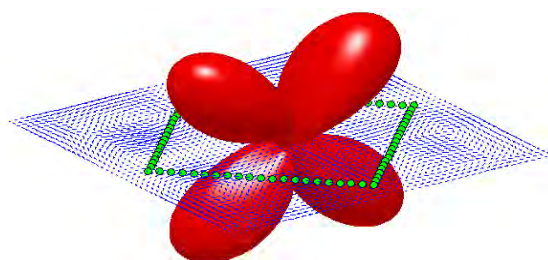

Fig. 14. Radiation pattern at the frequency of 3.4 GHz, horizontal polarization.

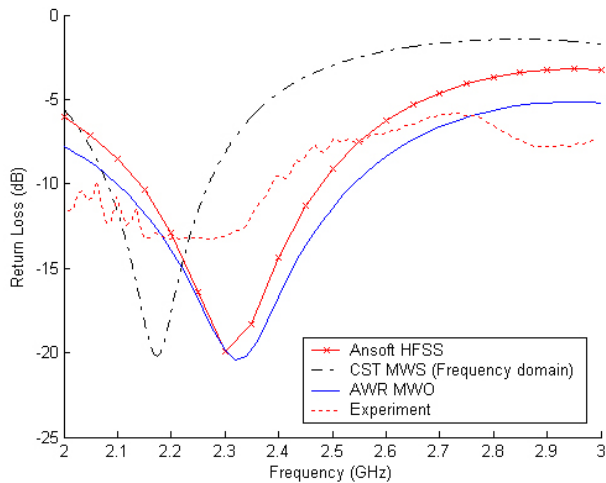

Fig. 15. The simulated and measured return loss of SRA.

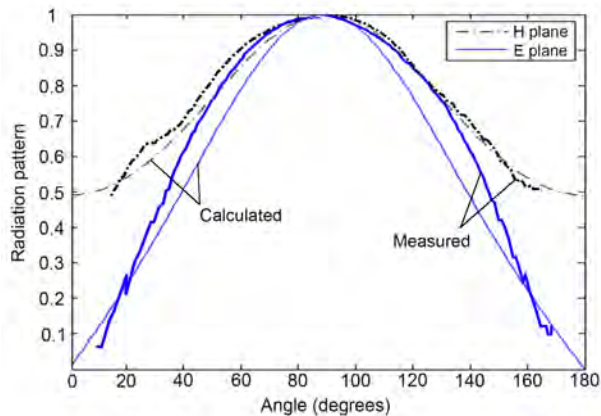

Fig. 16. The calculated and measured radiation pattern of SRA.

In a series of experimental research on the SRA characteristics a reduced cross polarized radiation in the normal direction has been obtained, its value being less than a maximum one by 18 dB. In the  $E$  plane the radiation pattern of the cross polarized signal is asymmetric, since the top and bottom of the rhomb radiate the energy of different values, which is caused by the attenuation of the wave during its propagation in the slot line.

#### 4. Conclusion

It has been shown that radiation phenomena of a slot rhombic antenna can be calculated by means of the decomposition method using the principle of induced electromotive forces. To simulate electrodynamic characteristics a double array of vertical and horizontal infinitesimally thin dipoles can be used. The model takes into account the influence of the dielectric on the propagation of electromagnetic waves in the slot line and the effect of the metal screen edges on the radiation parameters. The impact of the size of the metal screen on the electrodynamic characteristics of the slot antenna has been investigated.

The accuracy of numerical solution has been found to be significantly higher by comparison with full-wave 3D electromagnetic simulation tools. The results show

that the proposed method does not require sophisticated computing resources owing to its simplicity and the significant decrease in the number of unknowns.

Obtained electrodynamic characteristics, confirmed by the experimental data, verify the presence of broadside radiation in a wide frequency range.

The approach discussed in Section 2 can be applied to slot radiators of arbitrary form on thin dielectric substrates, antenna arrays made of slot radiators and slot antennas with circular polarization.

#### References

- [1] A. D. Blumlein, Improvements in or relating to high frequency electrical conductors or radiators. GB Patent: GB515684 (A), issue date December 12, 1939.
- [2] V. P. Shestopalov, Physical principles of millimeter and submillimeter technics. V.1. Open structures. Kyiv, Ukraine: Nauk. dumka, 1985. (Russian)
- [3] A. Drabkin, et al., *Antenna-feeder devices*. Moscow, Russia: Soviet radio, 1974. (Russian)
- [4] J. W. Greiser, "Coplanar stripline antenna", *Micro-wave Journal*, vol. 19, № 10, pp. 47-49, Oct. 1976.
- [5] H.-C. Liu, T.-S. Horng and N. G. Alexopoulos, "Radiation of printed antennas with a coplanar waveguide feed", *IEEE Trans. Antennas and Propagation*, vol. 43, № 10, pp. 1143 – 1148, Oct. 1995.
- [6] R. Garg, P. Bhartia, I. Bahl, A. Ittipiboon, *Microstrip Antenna Design Handbook*. Boston, London: Artech House, Inc., 2001.
- [7] B. Oswald, U. Lott, and M. Spuehler, *Portable access authorization device, GPS receiver and antenna*. Patent: EP 1 170 704 (A1), issued date January 9, 2002.
- [8] K. Satoru, et al., *Annular-slot antenna*. Patent: EP 1 434 302 (A1), issued date June 30, 2004.
- [9] O. Hideaki, M. Tatsuo, *Plane antenna and its designing method*. Patent: WO 03105278 (A1), issued date December 18, 2003.
- [10] S. Pei-Lun, et al., *Dual band slot antenna with single feed line*. Patent: US2003090426 (A1), issued date May 15, 2003.
- [11] D. M. Pozar, *Microwave Engineering 4th Edition*. Hoboken, U.S.: A John Wiley & Sons, Inc., 2012.
- [12] R. S. Elliott, *Antenna Theory & Design*. Hoboken, U.S.: John Wiley & Sons, Inc., 2003.
- [13] H. Jasik (ed.), *Antenna Engineering Handbook, 1st Edition*. New York, U.S.: McGraw-Hill, 1961.
- [14] J. W. Greiser, *Coplanar stripline antenna*. US Patent: 4 063 246, issued date December 13, 1977.
- [15] A. Pistol Kors, *Antennas*. Moscow, Russia: Sviazizdat, 1947. (Russian)
- [16] H. G. Booker, "Slot Aerials and Their Relation to Complementary Wire Aerials", *J. Inst. Elect. Eng*, part III A, vol. 93, pp. 620-626, 1946.
- [17] D. N. Voskresenskii, et al., *Computer-aided design of antennas and microwave devices*. Moscow, Russia: Radio and Communications, 1988. (Russian)

- [18] F. Gustrau, D. Manteuffel, EM Modeling of Antennas and RF Components for Wireless Communication Systems. Berlin, Heidelberg: Springer, 2006.
- [19] K. C. Gupta, P. Bhartia, R. Garg, I. Bahl, *Microstrip Lines and Slotlines*. London, U.K.: Artech House, Inc., 1996.

### МОДЕЛЮВАННЯ ПОЛЯ ВИПРОМІНЮВАННЯ ЩІЛИННОГО ВИПРОМІНЮВАЧА В ЕКРАНІ СКІНЧЕНИХ РОЗМІРІВ

Віктор Гоблик, Олексій Ліске

Декомпозиційним методом із застосуванням методу наведених електрорушійних сил досліджено випромінюючу структуру на базі щілинної лінії передачі. Проаналізовано вплив розмірів екрану на розподіл поверхневих струмів. Обчислені ко- та крос-поляризовані діаграми спрямованості щілинної ромбічної антени. Встановлено, що щілинна ромбічна антена має поперечне випромінювання у смузі частот 1.85-2.8 ГГц. Здійснено вимірювання діаграми спрямованості та коефіцієнта стоячої хвилі

напруги сконструйованої щілинної ромбічної антени.



**Viktor Hoblyk** – PhD, Associate-Professor, Deputy Head of the Department of Electronic Means of Computer Aided Technologies, Institute of Telecommunications, Radioelectronics and Electronic Engineering, Lviv Polytechnic National University, Ukraine.



**Oleksiy Liske** – Assistant Professor at the Department of Electronic Means of Computer Aided Technologies, Institute of Telecommunications, Radioelectronics and Electronic Engineering, Lviv Polytechnic National University, Ukraine.