

Oksana Nadтока¹ and Oleg Yaroshchuk²

INVESTIGATION OF PHOTOINDUCED ORIENTATION ORDERING IN POLYMETHACRYLATES WITH SIDE-CHAIN AZOBENZENE MOIETIES

¹*Kyiv National Taras Shevchenko University,**64, Volodymyrska str., 01033 Kyiv, Ukraine; oksananadtoka@ukr.net*²*Institute of Physics, National Academy of Sciences, 46, Nauky Ave, Kyiv, Ukraine**Received: April 05, 2012 / Revised: June 25, 2012 / Accepted: October 01, 2012*

© Nadтока O., Yaroshchuk O., 2012

Abstract. The initial and the photoinduced 3D orientational order in the films of two methacrylic polymers containing azobenzene groups with electron-donor or electron-acceptor substituents was studied by using null ellipsometry and UV/Vis absorption spectroscopy. The 3D order was induced by monochromatic polarized light of two different wavelengths corresponding to pp^* and np^* absorption bands of azochromophores. We found that, depending on the excitation wavelength and terminal substituents of azochromophores, recording kinetics of photoinduced anisotropy in the polymers is dominated by either angular redistribution or angularly selective *trans-cis* isomerization of the chromophores originally being mainly in the *trans*-form. Before irradiation, the azobenzene groups in the films of all polymers show preference to the out-of-plane ordering. Scenario of the order transformation under irradiation depends on the prevailing mechanism of the photoinduced anisotropy. In case of angular redistribution, initial positive uniaxial order of azochromophores is transformed into the negative uniaxial order characterized by random orientation of these units in the plane perpendicular to the polarization direction of the exciting light. In turn, in case of photoselection, the chromophores approach a zero-order (spatially isotropic) state due to exhaustion of the anisotropic *trans*-isomers in all directions. The transient orientational structures in these kinetic processes are biaxial.

Keywords: azopolymer, polymethacrylate, photoinduced orientation.

1. Introduction

In the past years, azo-dye-containing polymer systems have been the subject of intensive researches due

to their potential applications in photonics, optoelectronics, and optical signal processing [1, 2]. One of the main interests to these polymer systems is their birefringence property when they are irradiated with a linearly polarized light [3]. This birefringence comes from the ordering of the azobenzene groups through *trans-cis-trans* isomerization cycles, which leads to an excess of photochromic entities oriented perpendicularly to the light polarization direction. When the light is turned off, a large part of the photoinduced orientation is preserved [4, 5].

The time dependence of the photoinduced order in azobenzene polymers has been explained by Dumont *et al.* using a theoretical model, which takes into account the population in both the *trans*- and *cis*-metastable states [6-8]. This model considers that the polarized light induces a selective optical pumping (“angular hole-burning (AHB)”) and angular reorientations (AR) during the direct *trans-cis* and reverse *cis-trans* photoisomerizations and the *cis-trans* thermal back-relaxation. As a result, two mechanisms are combined, in proportions depending on molecular parameters and on irradiation conditions. The first mechanism is connected with the angular selectivity of the photoexcitation, which produces *angular hole burning*. This selective depletion of the ground state is common in all photochromic materials. If photoproducts are thermally and photochemically stable, the saturation of hole burning leads to a total depletion of the initial state. The second mechanism occurs when the photochromism is thermally or optically reversible (like *trans-cis* photoisomerization of the majority of azobenzene derivatives). In that case, molecules undergo a great number of photoisomerization cycles resulting in a kind of mechanical stirring, which induces a random-walk rotation of azochromophores. This process, known as

angular redistribution, leads to the accumulation of molecules perpendicularly to the polarization of the exciting light. More generally, after a great number of photoisomerization cycles, these two processes tend to minimize the probability of optical excitation.

In the past decade, several groups of scientists studied the influence of the molecular architecture on the orientational characteristics of photochromic polymers. In their study, Sekkat *et al.* [9] have investigated the photo-induced orientation in an azobenzene-containing polyglutamate film. An anisotropy in the *cis*-isomer orientation has been found when the film was irradiated with a linearly polarized UV light (360 nm), and a theoretical model has described the time dependence of this anisotropy. Furthermore, Natansohn *et al.* [10, 11] have studied the time dependence of the birefringence of poly[4-[2-(methacryloyloxy)ethyl] azobenzene] film (called pMEA) using polarized UV (360 nm) or visible (514.5 nm) light. A similar birefringence has been measured for the two wavelengths, but its value was lower than those observed in various polymers containing polar azobenzene groups. Pump irradiance and temperature dependences of the photoinduced anisotropy in a pMEA polymer film have also been studied and compared to simple theoretical predictions [12]. Yaroshchuk *et al.* [13, 14] using irradiation with the polarized light of two different wavelengths have found that the kinetics of photoinduced ordering of azochromophores in the amorphous and liquid crystalline azobenzene polyesters can be dominated by either AR or AHB mechanism depending on the time of thermodynamic and photostimulated relaxation of metastable *cis*-isomers determined, correspondingly, by the structure of photosensitive side chains and excitation wavelength. Moreover the ordering process was considered in a real 3D space allowing one to identify various spatial distributions of azochromophores. Theoretical consideration of these results was given in [13, 15].

Currently, using the methodology developed earlier in [13, 14, 16] we study features of the photoinduced ordering of azochromophores in methacrylic azopolymers. The case of $\pi\pi^*$ excitation of azochromophores was considered in [17, 18]. In the present paper we compare orientational transformation caused by $\pi\pi^*$ and $n\pi^*$ excitation. It is demonstrated that, just as for azopolyesters, the process of 3D order transformation depends essentially on the relaxation kinetics of the excited *cis*-isomers. This allows us to conclude that photoordering regularities established earlier in [13] are common for different classes of azopolymers and thus the theory of 3D ordering [13, 15] predicting these regularities is rather general.

2. Experimental

2.1. Materials Synthesis and Characterization

We used poly[4-(methacryloyloxy)-4'-nitroazobenzene] (**P1**) and poly[4-(methacryloyloxy)-4'-methoxyazobenzene] (**P2**) differing by the donor/acceptor nature of end substitutes of the side-chain azochromophore. The general formula of these compounds is presented in Fig. 1. It is evident that the polymers differ only by the end fragment R, which is NO₂ and OCH₃ in polymers **P1** and **P2**, respectively.

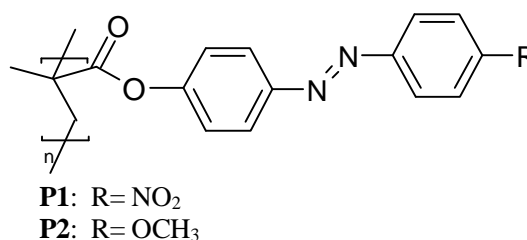

Fig. 1. General formula of azopolymers

Synthesis of the two polymers was similar, and only the general steps towards making polymers are detailed.

Monomer synthesis. The corresponding monomers were synthesized by general methods. The azocompound (0.06 mol) and triethylamine (9.0 ml) were dissolved in THF (200 ml). The solution was kept in an ice bath for 10 min. A solution of distilled methacryloyl chloride (6.0 ml, 0.06 mol) was added slowly to the above mixture. After the addition of methacryloyl chloride, the resulting mixture was stirred at room temperature overnight. Then the solution was poured into distilled water (1 l) and the obtained residue was filtered and air-dried. Recrystallization of monomers was carried out in ethanol.

4'-methacryloxy-4-nitroazobenzene (M1) Orange crystals; yield 69 %; mp 418 K (by DSC). ¹H NMR (CDCl₃), *d* (ppm): 8.43 (d, 2H, Ph-H *ortho* to NO₂), 8.07 (d, 2H, Ar), 8.03 (d, 2H, Ar), 7.40 (d, 2H, Ar), 6.34 (s, 1H, =CH₂), 5.91 (s, 1H, =CH₂), 2.05 (s, 3H, -CH₃). UV-vis (Ethanol) *I*_{max}: 360, 485 nm. Elem. Anal. Calc. for C₁₆H₁₃O₄N₃: C, 61.74 %, H, 4.18 %; N, 13.50 %. Found: C, 61.70 %, H, 4.16 %; N, 13.52%.

4'-methacryloxy-4-methoxyazobenzene (M2): Yellow crystals; yield 65 %; mp 545 K (by DSC). ¹H NMR (CDCl₃), *d* (ppm): 7.85 (d, 2H, Ar), 7.65 (d, 2H, Ar), 7.74 (d, 2H, Ar), 6.91 (d, 2H, Ar), 6.30 (s, 1H, =CH₂), 5.84 (s, 1H, =CH₂), 2.08 (s, 3H, -CH₃),

4,2 (m, 2H, CH₂) 1,72 (m, 3H, CH₃) UV-vis (Ethanol) I_{max} : 378, 500 nm. Elem. Anal. Calc. for C₁₇H₁₆O₃N₂: C, 60.59 %, H, 6.82 %; N, 7.95 %. Found: C, 60.62 %, H, 6.80 %; N, 7.93%.

Polymerization. Homopolymers P1 and P2 were synthesized by free-radical polymerization in toluene from monomers M1 and M2, respectively. The polymerization was carried out in 10 wt % toluene solution of monomer with AIBN as free radical initiator (10 wt.% of monomer) at 353 K over more than 30 h. Polymers were isolated from the reaction solution by precipitation into excess of methanol followed by reprecipitation from toluene into methanol and then dried at 293 K overnight. The synthetic work is described in more details in a separate paper [18].

The synthesized polymethacrylates were characterized by elemental analysis and ¹H NMR spectroscopy. The results are in agreement with the proposed structures. Molecular weights of polymers were determined by gel permeation chromatography. The data for number-average molar mass M_n are presented in Table 1. The phase transition temperatures of the polymers were studied by DSC technique. The obtained data are presented in Table 1. As can be seen, both polymers are amorphous with a rather high temperature of glass transition. Molecular weights of the polymers (M_n) were determined by gel permission chromatography. The obtained values of M_n are rather low (Table 1), which is apparently caused by the ability of azogroups in azomonomers to serve as “traps” for radicals. As a result, in the course of polymerization, the role of termination and chain-transfer reactions markedly increases.

Table 1

Characteristics of polymers

Polymer	R	T_g , K	M_n , g/mol	I_{max} , nm
P1	NO ₂	435	5600	360
P2	OCH ₃	432	5900	343

2.2. Film Preparation and Illumination

The polymers were dissolved in chloroform at the concentration of 2 wt %. The filtered solutions were used to spin coat the polymer films onto quartz slides. The films were kept for 30 min at 353 K to remove any remaining solvent. The film thickness measured with a profilometer was 300–500 nm. These films were of good optical uniformity.

The photoordering processes were initiated by irradiation with polarized light directed normally to the films. Two different wavelengths were used to pump the samples:

(1) $I_{ex1} = 365$ nm, from a mercury lamp, selected by an interference filter and polarized with a Glan prism. The light intensity I was varied in the range of 4–10 mW/cm².

(2) $I_{ex2} = 480$ nm from an Ar⁺ laser ($I \gg 20$ mW/cm²).

As it will be shown below, the lines $I_{ex1} = 365$ nm and $I_{ex2} = 480$ nm correspond to $p \rightarrow p^*$ and $n \rightarrow p^*$ excitation, respectively. In all cases the polarization of exciting light (E_{ex}) was chosen along the x axis of the Cartesian coordinate system with x and y axis parallel to the verges of the rectangular polymer film and z axis normal to this film (Fig. 2).

2.3. Methods of Studying of 3D Orientational Order

In these studies the *transmission null ellipsometry* (TNE) method dealing with refractive indices has been adapted to azopolymers. The optical scheme of the method is presented in Fig. 2. The probe beam (628 nm) is linearly polarized at 45° with respect to the in-plane main axes of the sample. The elliptically polarized transmitted beam is converted into a linearly polarized beam by a quarter wave plate (axis parallel to that of the polarizer). The angle j of the output polarization, determined by rotation of a linear analyzer, gives the in-plane retardation ($n_y - n_x$) d . Then the sample is rotated around the x axis vertically aligned and the polarization angle j is measured as a function of the incidence angle q . The out-of-plane retardation ($n_z - n_x$) d is determined by fitting a theoretical expression of $j(q)$. The TNE was used to study 3D orientation of azochromophores in both polymers, before irradiation and after successive irradiation steps with $I_{ex1} = 365$ nm and $I_{ex2} = 480$ nm exciting light.

As a complementary characterization method we also perform 2D-dichroism measurement in the UV/visible spectral range. The UV/vis absorption measurements were carried out using a S2000 diode array spectrometer from Ocean Optics Co. The samples were set normally to the testing light from a low intensity deuterium lamp. A Glan-Thomson prism was used to polarize the probe beam.

The optical densities (D_x and D_y) corresponding to x and y in-plane polarizations, are measured with a probe beam propagating perpendicularly to the sample. The third component (D_z) is estimated by the *total absorption (TA) method*, which presumes the conservation of the total absorption $D_{tot} = D_x + D_y + D_z$. The D_{tot} can be easily obtained, if at some instant of time t_0 the sample is uniaxial, with an in-plane orientation of the axis of anisotropy, say x . Then:

$$D_{tot} \approx D_x(t_0) + D_y(t_0) + D_z(t_0) = D_x(t_0) + 2D_y(t_0) \quad (1)$$

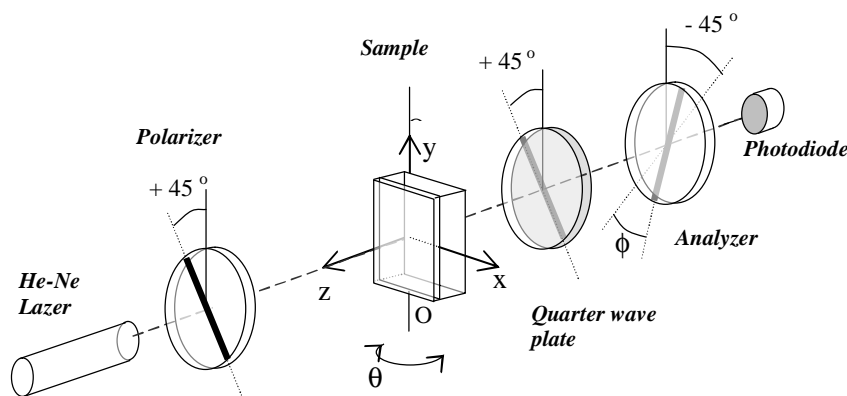

Fig. 2. Optical layout of null ellipsometer

If the number of azobenzene units in *trans* configuration remains constant at each instant of time t , D_z can be estimated as:

$$D_z(t) = D_{tot} - D_x(t) - D_y(t) \quad (2)$$

where $D_x(t)$ and $D_y(t)$ are experimentally measured. Then, the diagonal terms of the tensor of orientational order S_{ij} can be estimated. For example:

$$S_{xx} = \frac{D_x - \frac{1}{2}(D_y + D_z)}{D_x + D_y + D_z} \quad (3)$$

The components S_{yy} and S_{zz} can be obtained by cyclic permutation in expression (3).

The total absorption method can be applied in some experimental situations described below.

3. Results and Discussion

3.1. Electronic Spectra

In our study we perform polymers containing azobenzene groups with electron-donor and electron-acceptor substituents, which strongly absorb in the visible region of the electronic spectrum. Fig. 3 shows the absorption spectrum in the 300–600 nm regions of a **P1** and **P2** polymer films before irradiation. These UV-vis spectra display high-intensity pp^* bands in the UV (at about 350 nm) and low-intensity np^* bands in the visible region (at about 450 nm) [19]. Considering the absorption spectra of *trans*- and *cis*-azobenzene [18], the band at nearly 350 nm corresponds essentially to the absorption of the *trans*-isomers while the band at about 450 nm is mainly due to the absorption of the *cis*-isomers. The exact positions of the maximum of the pp^* absorption bands, I_{max} , are presented in Table 1. A red shift of **P1** spectrum is explained by stretching of p electronic system of azochromophore due to the presence of electron-donor NO_2 group.

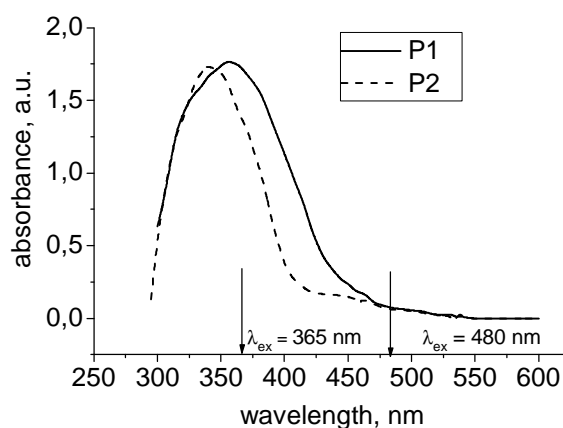

Fig. 3. The absorption spectra of **P1** and **P2** polymer films

3.2. Photoinduced Ordering: Case of $I_{ex} = 365$ nm Irradiation

At first we consider polymer **P1** containing push-pull chromophore. The values of the in-plane, $(n_y - n_x)d$, and the out-of-plane $(n_z - n_x)d$ retardation measured for the film of this polymer after successive exposure steps are presented in Fig. 4a. It is evident that before irradiation azochromophores demonstrate slight preference to the out-of-plane orientation ($n_z > n_x = n_y$, Fig. 4a). This prolate uniaxial order is caused by a selforganization in the **P1** film. In the stationary state of irradiation, $n_x < n_y = n_z$. This implies that the UV exposure results in transformation of the initial prolate order with z axis into the oblate uniaxial order with x axis determined by the symmetry of light field. The ratio $n_x < n_y = n_z$ implies that the azochromophores are randomly distributed in the plane perpendicular to the light polarization direction. The transient orientational structures are biaxial ($n_x^{-1} n_y^{-1} n_z$).

The in-plane components of optical density, D_x and D_y , of the same **P1** film are presented in Fig. 4b.

Initially, $D_x=D_y$, which reflects in-plane isotropy of azochromophores. In a course of irradiation, D_y increases while D_x decreases. This suggests that azochromophores are partially redistributed from x to y direction, *i.e.*, perpendicularly to E_{ex} . These changes correspond to reorientation mechanism [6-8] implying that concentration of *cis*-isomers after irradiation steps is negligible. In this case, total absorption approach can be applied. D_{tot} can be easily obtained, because, according to Fig. 4a, $D_z=D_y$ in the photostationary state. Then D_z after each step of exposure can be estimated by using Eq. (2). These data are presented in Fig. 4a too.

The values of D_x , D_y , and D_z are used to calculate order parameters as described above in the Experimental section. The oblate initial order is described with the parameters $S \equiv S_{zz} = 0.08$ and $S_{xx} = S_{yy} = -S_{zz}/2 = -0.04$ (positive uniaxial order along z axis). At saturation, $S \equiv S_{xx} = -0.145$ and $S_{yy} = S_{zz} = -S_{yy}/2 = 0.073$ (uniaxial negative order along x axis). The transient order is biaxial, *i.e.*, $S_{xx} \neq S_{yy} \neq S_{zz}$.

The retardation curves for the **P2** film are shown in Fig. 5a. Similarly to **P1**, the initial state of this film is characterized with the prolate uniaxial order along z axis. The UV light transforms this order to biaxial ($n_x \neq n_y \neq n_z$). At long exposures, the film approaches spatially isotropic state where ratio $n_z = n_x = n_y$ is fulfilled.

The $D_x(t)$ and $D_y(t)$ curves for the **P2** film are presented in Fig. 5b. In contrast to the case of **P1**, both D_x and D_y values decrease with irradiation. This indicates that the azobenzene chromophores order due to angular photoselection mechanism [6-8]. The conversion of *trans*-isomers in the long living *cis*-form first in the direction of light polarization E_{ex} and then in all other spatial directions may explain isotropic order realized in **P2** film at high irradiation doses. Because of growing concentration of *cis*-isomers with exposure time, the total absorption is not preserved and so D_z component cannot be estimated. In turn, it does not allow to calculate the order parameter components for the initial and transient stages. In the photosaturation state, $S_{xx} = S_{yy} = S_{zz}$.

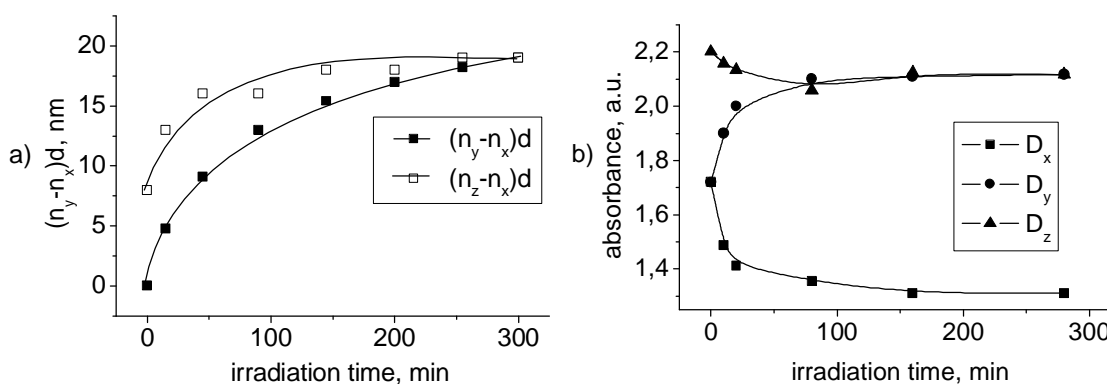

Fig. 4. The in-plane and out-of-plane phase retardations (a) and the principal optical density components D_x , D_y and D_z (b) for the film of polymer **P1** as functions of exposure time. The light parameters are $I_{ex1} = 365$ nm, $I = 5$ mW/cm², linear polarization along the x axis

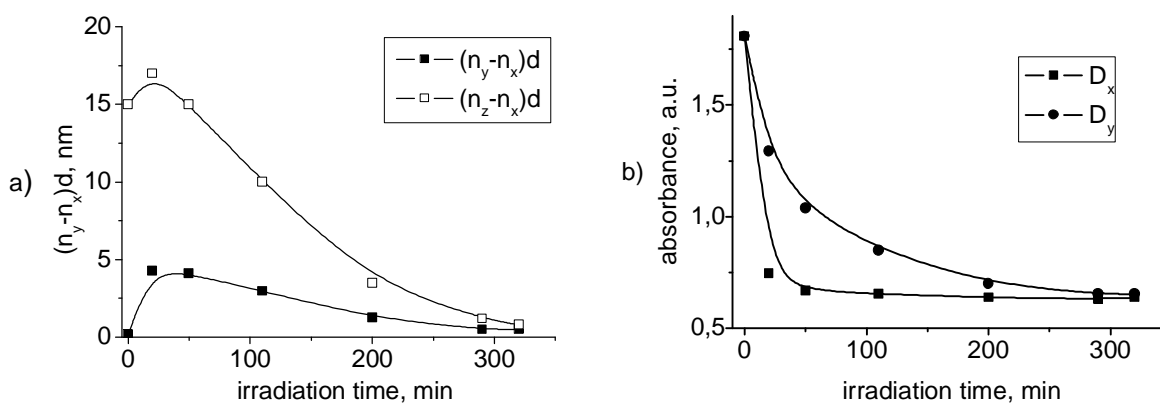

Fig. 5. The in-plane and out-of-plane phase retardations (a) and the principal optical density components D_x and D_y (b) for the film of polymer **P2** as functions of exposure time. The light parameters are $I_{ex1} = 365$ nm, $I = 5$ mW/cm², linear polarization along the x axis

3.2. Photoinduced Ordering: case of $I_{ex} = 480$ nm Irradiation

The phase retardation $(n_y - n_x)d$ and $(n_z - n_x)d$ vs. irradiation time curves for **P1** and **P2** films are presented in Figs. 6a and 7a, respectively. One can see that in both cases, similarly to $I_{ex} = 365$ nm irradiation of **P1** film, initial upright prolate uniaxial order is continuously transformed through the number of biaxial structures in the oblate uniaxial order with the ordering axis lying in plane of the film parallel to the light polarization direction (x axis). The transient orientational structures are biaxial ($n_x \neq n_y \neq n_z$). Similar kinetics of phase retardation suggests similar photoordering mechanisms.

The absorption vs. exposure time curves for **P1** and **P2** are presented in Figs. 6b and 7b, respectively. The behavior of $D_x(t)$ and $D_y(t)$ curves for **P1** film is similar to that for $I_{ex} = 365$ nm irradiation and implies reorientation mechanism of photoordering. Interestingly, similar trend is observed for **P2** that contrasts well with the case of $I_{ex} = 365$ nm irradiation of this polymer. The ordering according to reorientation mechanism suggests that concentration of *cis*-isomers in both polymers at $I_{ex} = 480$ nm irradiation is small. For **P1** this is primarily due to short lifetime of *cis*-isomers, while in case of **P2** this is caused by high excitation probability of *cis*-isomers and their forced transition to the initial *trans*-form. As a result, azochromophores undergo many cycles of *trans-cis-trans* isomerization and eventually accumulate in the directions perpendicular to E_{ex} [14]. A small concentration of *cis*-form allows one to apply a total absorption approach for calculation of D_z . The calculated $D_z(t)$ curves are added to the $D_x(t)$ and $D_y(t)$ plots in Figs. 6b and 7b.

The values of D_x , D_y , and D_z were used to estimate order parameters for various states. Below only uniaxial

structures are characterized. The upright prolate order before irradiation is described with the parameters $S \equiv S_{zz} = 0.084$ and $S_{xx} = S_{yy} = -S_{zz}/2 = 0.042$ for **P1** and $S \equiv S_{zz} = 0.09$ and $S_{xx} = S_{yy} = -S_{zz}/2 = 0.045$ for **P2**. One can conclude that the spontaneous ordering in the initial state is rather weak and it slightly enhances with adding hydrophobic tails to azobenzene side chains. The oblate uniaxial distribution of azochromophores with the x ordering axis, realized in the stationary state of irradiation, is characterized by the scalar $S \equiv S_{xx} = -0.13$ for **P1** and $S \equiv S_{xx} = -0.11$ for **P2**.

The values of photoinduced in-plane birefringence and order parameter corresponding to saturation state of irradiation are gathered in Table 2. The birefringence values were extracted from the values of phase retardation by measuring film thickness d with a profilometer. It is noteworthy that the value of the photoinduced birefringence of about 0.15 is attained. This makes the studied polymers attractive for various photonic applications, such as information processing and storage, holography, waveguides, etc.

Table 2

The values of the photoinduced order parameter $|S_{xx}|$ and in-plane birefringence $n_y - n_x$ for the films of azopolymers in the saturation state

Polymer	Irradiation with polarized UV light ($I_{ex1} = 365$ nm)		Irradiation with polarized visible light ($I_{ex2} = 480$ nm)	
	$ S_{xx} $	$n_y - n_x$	$ S_{xx} $	$n_y - n_x$
P1	0.15	0.13	0.13	0.07
P2	Isotropic		0.11	0.02

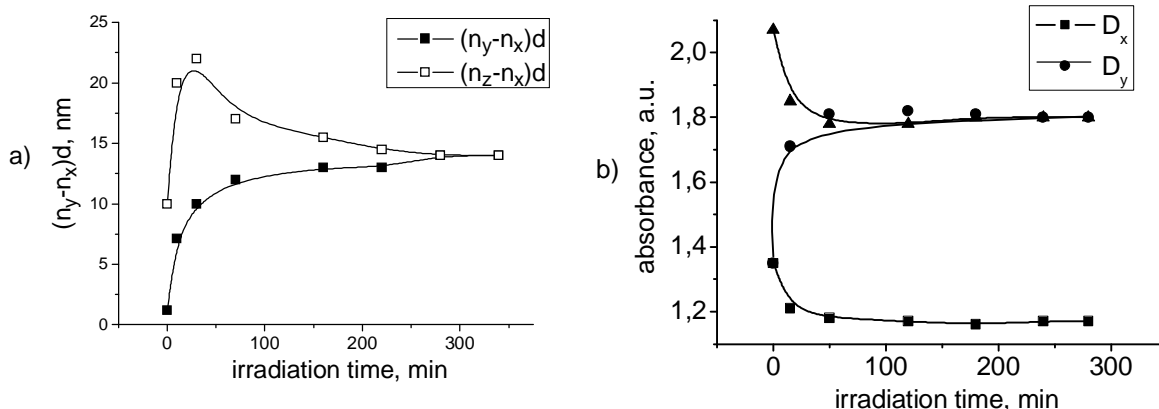

Fig. 6. The in-plane and out-of-plane phase retardations (a) and the principal optical density components D_x , D_y , and D_z (b) for the film of polymer **P1** as functions of exposure time. The light parameters are $I_{ex2} = 480$ nm, $I = 15$ mW/cm², linear polarization along the x axis

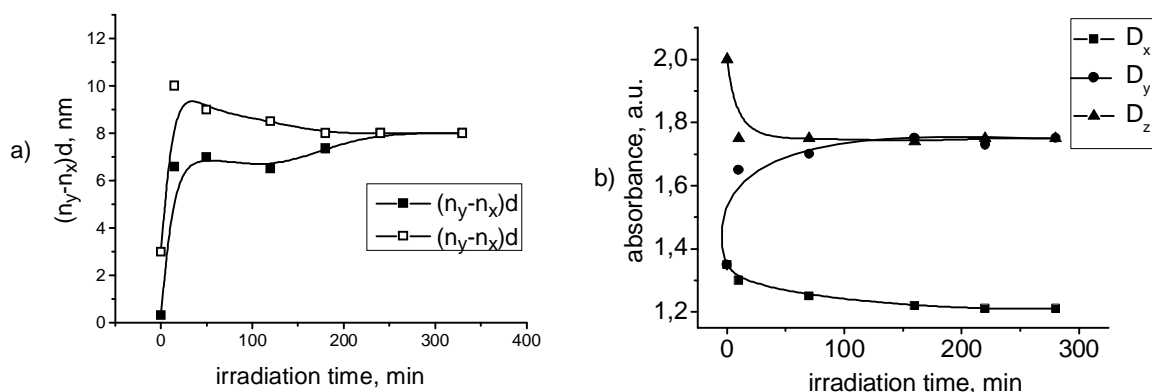

Fig. 7. The in-plane and out-of-plane phase retardations (a) and the principal optical density components D_x , D_y and D_z (b) for the film of polymer **P2** as functions of exposure time. The light parameters are $I_{ex2} = 480$ nm, $I = 15$ mW/cm², linear polarization along the x axis

4. Conclusions

We studied the photoinduced ordering processes in methacrylic azopolymers having substituents of different nature in side-chain chromophores. The results show that the photoinduced order strongly depends on the structure of chromophores as well as on the spectral composition of light, as described below. The molecular structure determines the photoorientation properties of azochromophores by modifying their photochemical properties and intrinsic self-organization. Irradiation of these polymer films with a polarized light of 365 nm and 480 nm, corresponding to prevailing absorption of *trans*- and *cis*-chromophores, respectively, leads to photoordering according to different mechanisms.

In polymer **P1** with acceptor substituents (NO₂) in azobenzene moieties, the lifetime of *cis*-isomers is short and thus, regardless of the wavelength of exciting light, numerous *trans-cis-trans*-isomerization cycles occur during irradiation. These excitations are accompanied by rotation of azochromophores and their accumulation in the direction perpendicular to the exciting light polarization E_{ex} . A similar ordering process takes place in the film of **P2** at $I_{ex} = 480$ nm, when excitation probability of *cis*-isomers is higher or comparable with that of *trans*-isomers. In this case the multiple cycles of *trans-cis-trans*-isomerization occur due to photoexcitation of both *trans*- and *cis*-isomers. This mechanism, usually called angular redistribution, is rather typical for azopolymers [5-9]. In contrast to case of $I_{ex} = 480$ nm, at $I_{ex} = 365$ nm the long living azochromophores of **P2** do not undergo multiple excitations and thus ordering is induced due to angular hole burning.

The 3D orientational order is observed in the non-irradiated films as well as the films after irradiation. Before irradiation, the azochromophores of both

polymers show preference to the out-of-plane ordering (upright prolate uniaxial order). The transformation of this order under irradiation depends on the prevailing mechanism of the photoinduced anisotropy. In case of AR mechanism, the initial order is transformed into the oblate uniaxial order with the ordering axis coinciding with a light polarization direction E_{ex} . It is characterized by random orientation of azochromophores in the plane perpendicular to E_{ex} . In turn, in case of AHB, the chromophores approach the spatially isotropic state due to exhaustion of *trans*-isomers in all directions. The transient orientational structures in these kinetic processes are biaxial.

The regularities we observed for the studied polymers are in good agreement with the regularities earlier observed for azobenzene polyesters [14] as well as for the polymers with photosensitive cinnamoyl groups [20]. Therefore, the regularities established may be the general rules, which can be used to predict orientational order in other types of polymers.

References

- [1] Xie S., Natansohn A. and Rochon P.: Chem. Mater., 1993, **5**, 403.
- [2] Natansohn A. and Rochon P.: Adv. Mater., 1999, **11**, 1387.
- [3] Todorov T., Nikolova L. and Tomova N.: Appl. Opt., 1984, **23**, 4309.
- [4] Natansohn A., Rochon P., Gosselin J. and Xie S.: Macromolecules, 1992, **25**, 2268.
- [5] Brown D., Natansohn A. and Rochon P.: Macromolecules, 1995, **28**, 6116.
- [6] Sekkat Z. and Dumont M.: Synth. Met., 1993, **54**, 373.
- [7] Dumont M., Froc G. and Hosotte S.: Nonlinear Opt., 1995, **9**, 327.
- [8] Dumont M. and El Osman A.: Chem. Phys., 1999, **245**, 437.
- [9] Sekkat Z., Wood J. and Knoll W.: J. Phys. Chem., 1995, **99**, 17226.
- [10] Natansohn A., Rochon P., Ho M. and Barrett C.: Macromolecules, 1995, **28**, 4179.

- [11] Ho M., Natansohn A., Barrett C. and Rochon P.: Can. J. Chem. 1995, **73**, 1773.
- [12] Hore D., Natansohn A. and Rochon P.: Can. J. Chem. 1998, **76**, 1648.
- [13] Yaroshchuk O., Kiselev A., Zakrevskyy Yu. et al.: Phys. Rev. E., 2003, **68**, 011803-1.
- [14] Yaroshchuk O., Dumont M., Zakrevskyy Yu. et al.: J. Phys. Chem. B, 2004, **108**, 4647.
- [15] Kiselev A., Yaroshchuk O., Zakrevskyy Yu. and Tereshchenko A.. Condensed Matter Physics, 2001, **4**, 67.
- [16] Yaroshchuk O., Tereshchenko A., Zakrevskyy Yu. and Shansky I.: Mol. Cryst. Liq. Cryst., 2001, **361**, 187.
- [17] Yaroshchuk O., Bidna T., Nadtoka O. et al.: Mol. Cryst. Liq. Cryst., 2005, **437**, 1377.
- [18] Nadtoka O., Yaroshchuk O., Bednaya T. et al.: Polym. Sci. A, 2010, **52**, 261.
- [19] Rau H.: Photochemistry and Photophysics. CRC Press, Boca Raton, FL 1990.
- [20] Yaroshchuk O., Sergan T., Kelly J. and Gerus I.: Jpn. J. Appl. Phys., 2002, **41**, 275.

ДОСЛІДЖЕННЯ ФОТОІНДУКОВАНОЇ ОРІЄНТАЦІЇ В ПОЛІМЕТАКРИЛАТАХ З БІЧ- НИМИ АЗОБЕНЗОЛЬНИМИ ФРАГМЕНТАМИ

Анотація. Вивчено кінетику фотоіндукованого впорядкування двох метакрилових полімерів, що містять азобензольні групи з електрон-донорними або електрон-акцепторними замісниками, при їх опроміненні за різних довжин хвиль. Експериментальні дослідження було проведено з використанням методів нуль-еліпсометрії та спектроскопії. Показано, що азофрагменти орієнтуються в залежності від довжини хвилі за механізмом фотоорієнтації або фотоселекції. За механізмом фотоорієнтації азохромофори спонтанно розміщуються в площині, перпендикулярній вектору поляризації світла E_{ex} . У випадку, коли переважає механізм фотоселекції, 3-мірний розподіл азохромофорів у стані насичення є ізотропним завдяки суттєвому вичерпанням анізотропних транс-ізомерів.

Ключові слова: азополімер; поліметакрилат, фотоіндукована орієнтація.